

PHASE 2

PHASE 1

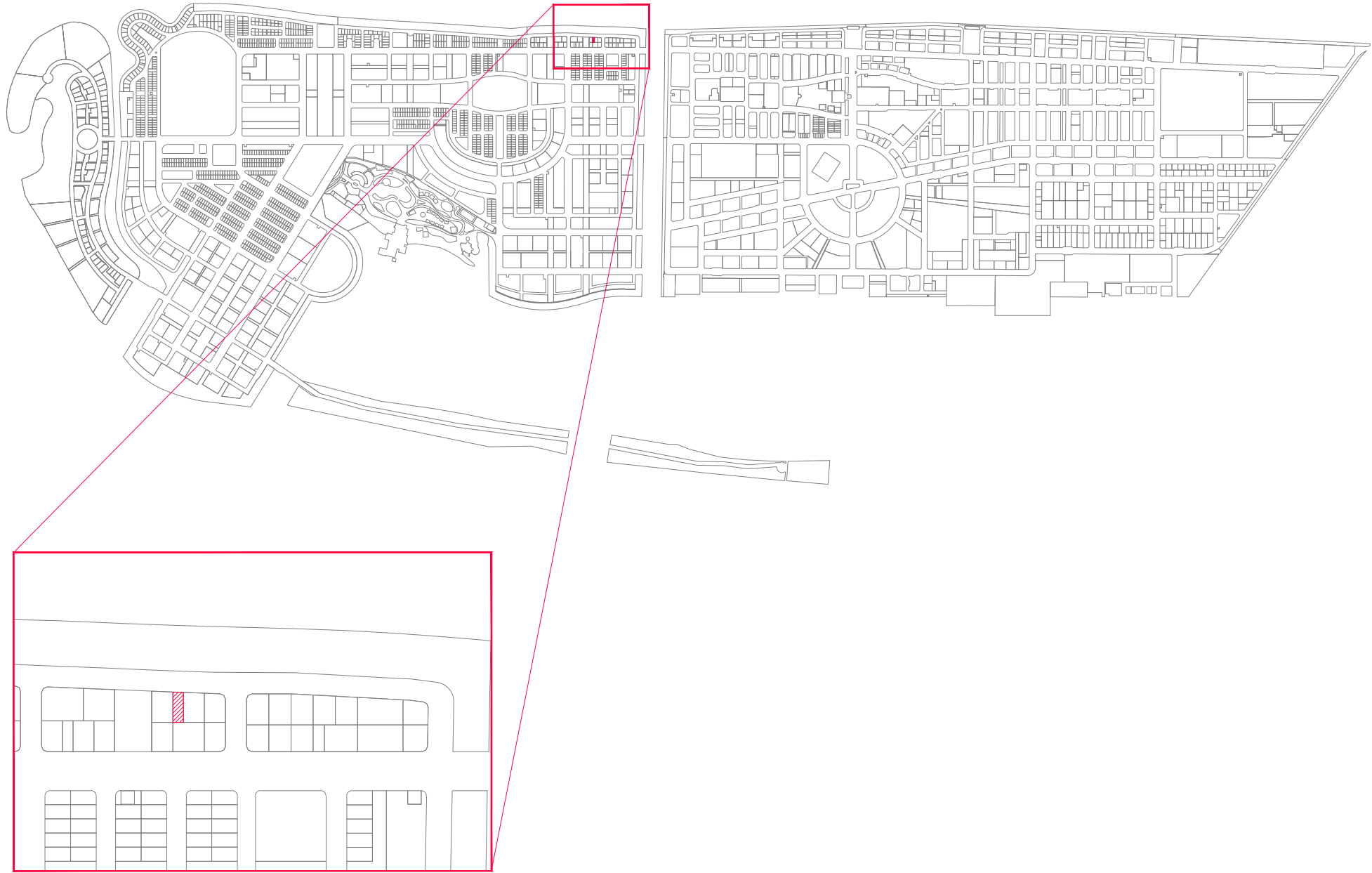

**LOT 20031
(RESIDENTIAL)**

Drawing Name : Location Map

Drawing Stage: Proposed map

Scale: N.T.S

PLANNERS

Drawn by:	Revised by:
-----------	-------------

Drawn date:

Checked by:

SURVEYORS

Surveyed by:	Revised by:
--------------	-------------

Surveyed date:	Revised Date:
----------------	---------------

Checked by:	Approved by:
-------------	--------------



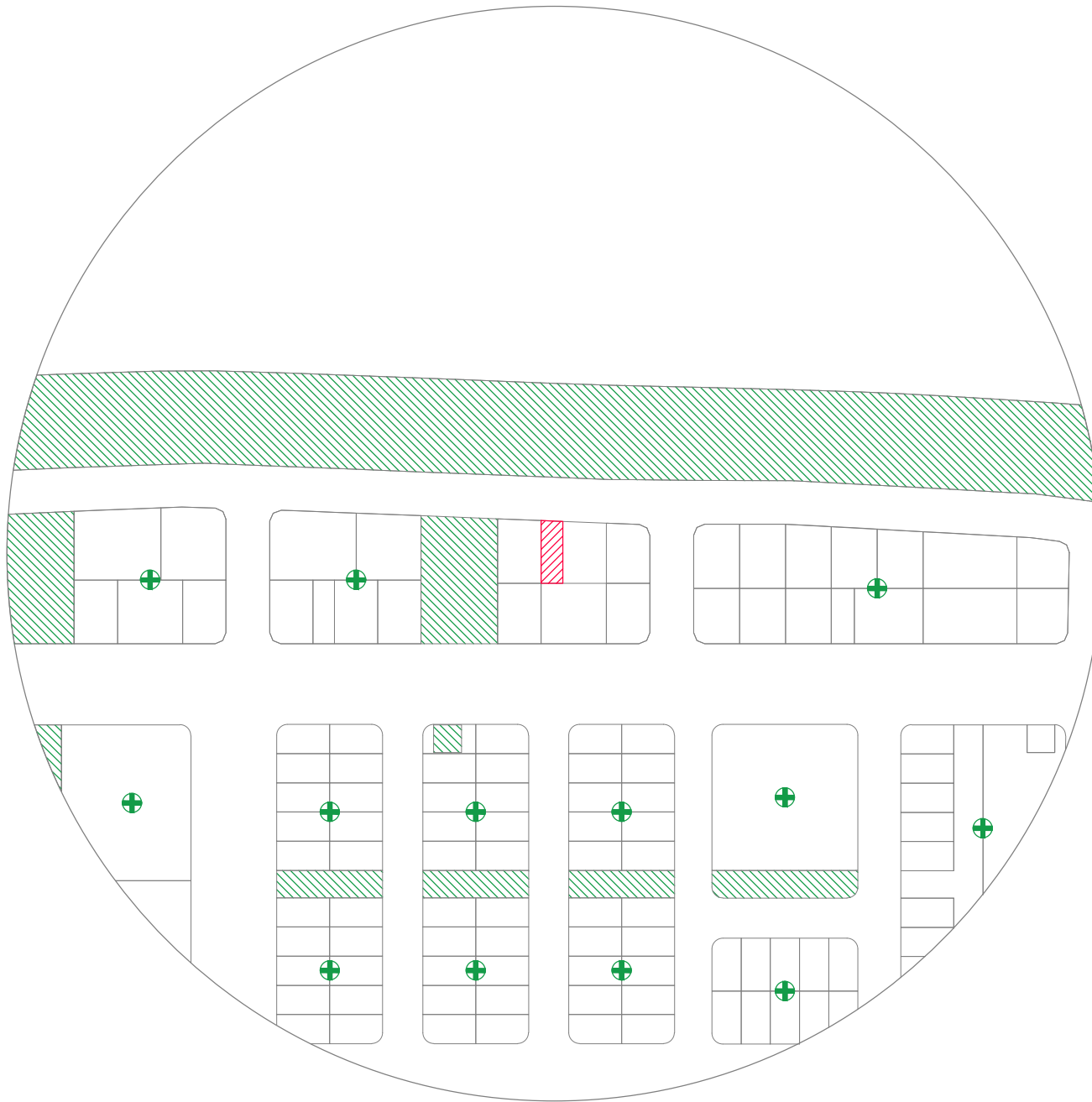

LEGEND:

-  COMPLETED
-  ONGOING
-  ALLOCATED
-  PROPOSED

LOT 20031 (RESIDENTIAL)		
Drawing Name : Site Context Plan	Drawing Stage: Proposed map	Scale: N.T.S

PLANNERS	
Drawn by: Hiyala	Revised by:
Drawn date: 13th May 2024	
Checked by:	

SURVEYORS	
Surveyed by:	Revised by:
Surveyed date:	Revised Date:
Checked by:	
Approved by:	





NIKAGAS MAGU

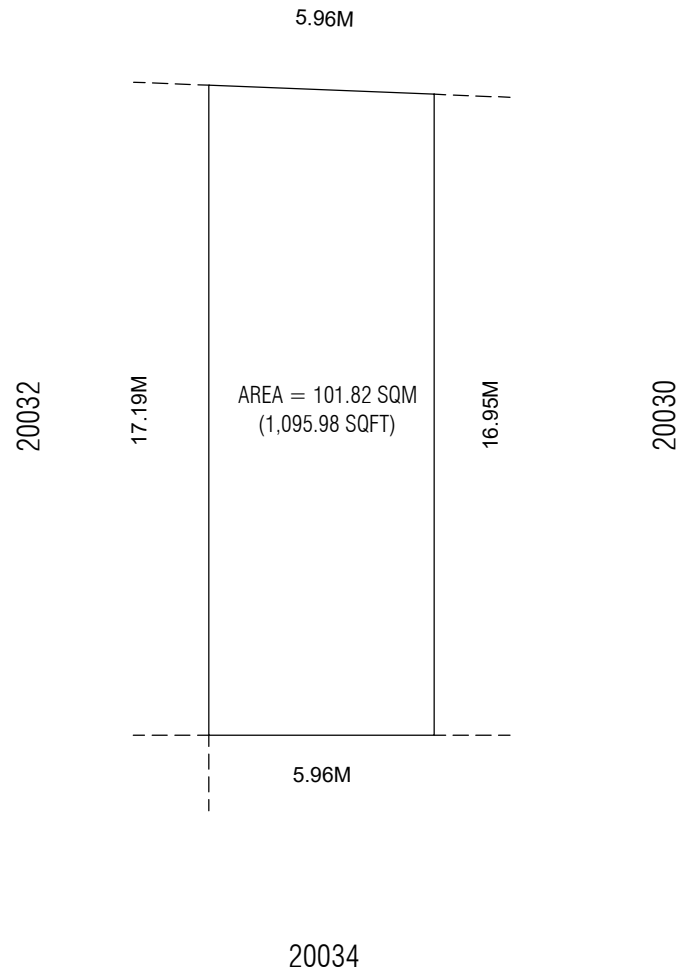

NOTE: This is not a surveyed map and is subject to minor changes.

LOT 20031 (RESIDENTIAL)		
Drawing Name : Plot Map	Drawing Stage: Proposed map	Scale: N.T.S

PLANNERS	
Drawn by: Hiyala	Revised by:
Drawn date: 13th May 2024	
Checked by:	

SURVEYORS	
Surveyed by:	Revised by:
Surveyed date:	Revised Date:
Checked by:	Approved by:



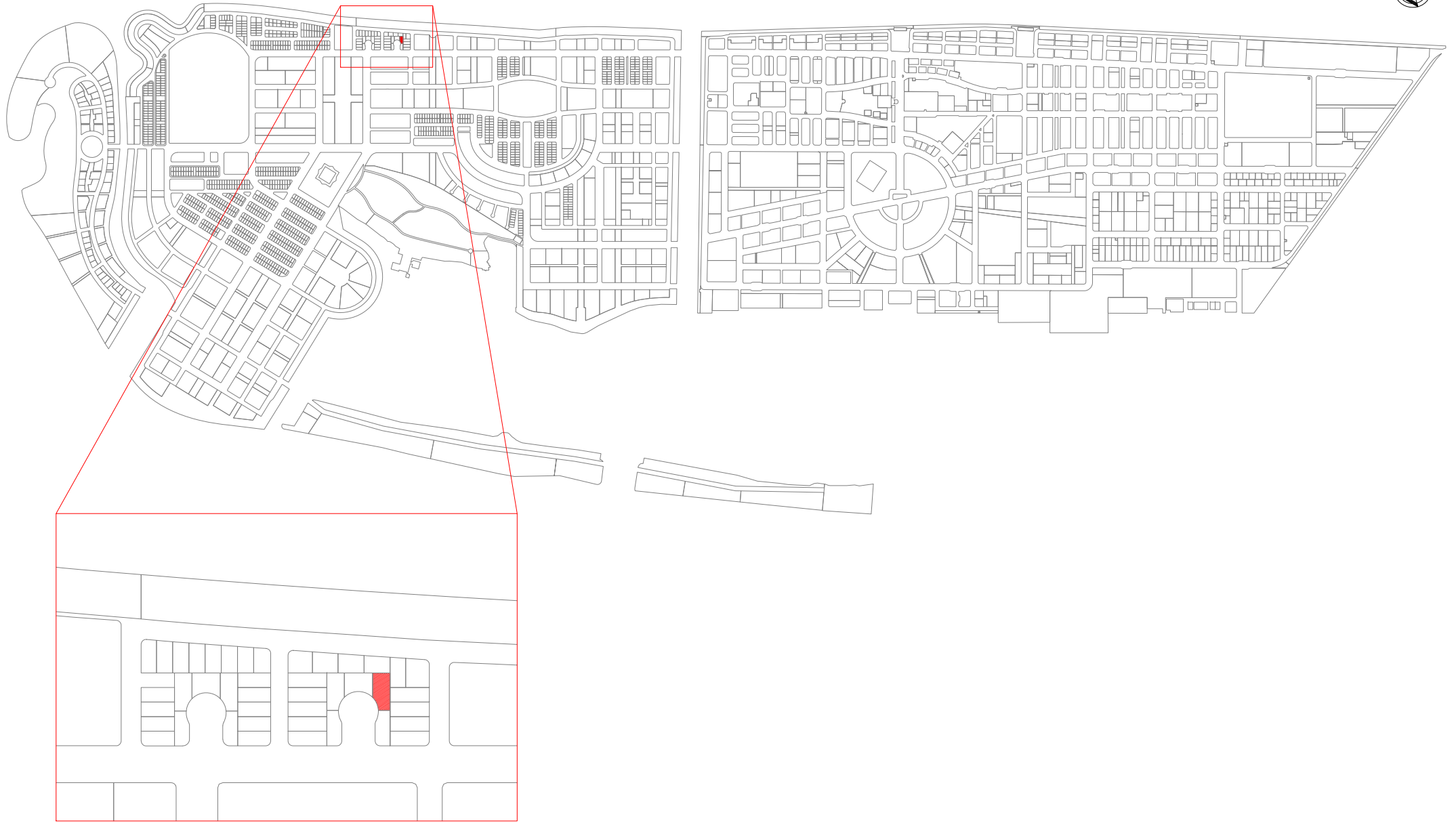

PROJECT: LOT 20331

Scale: N.T.S

Drawn by: Thorif Ibrahim

Checked by: Muhammed Ibrahim

Date: 16th October 2022

DRAWING: LOCATION MAP

Remarks:

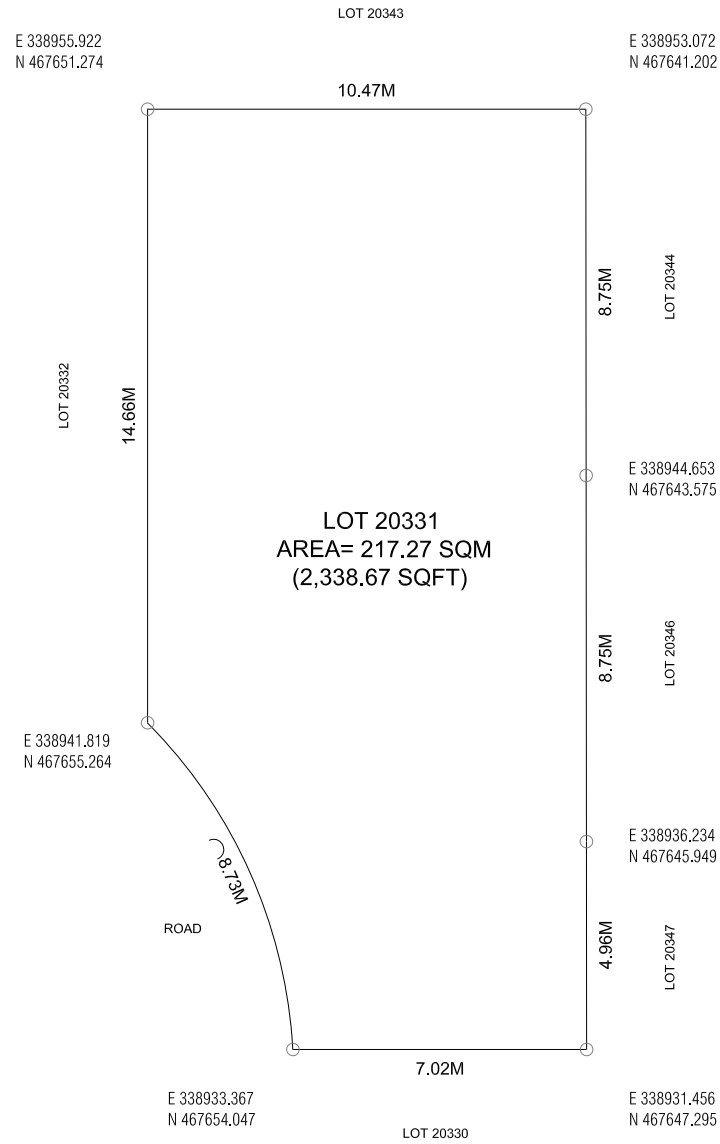

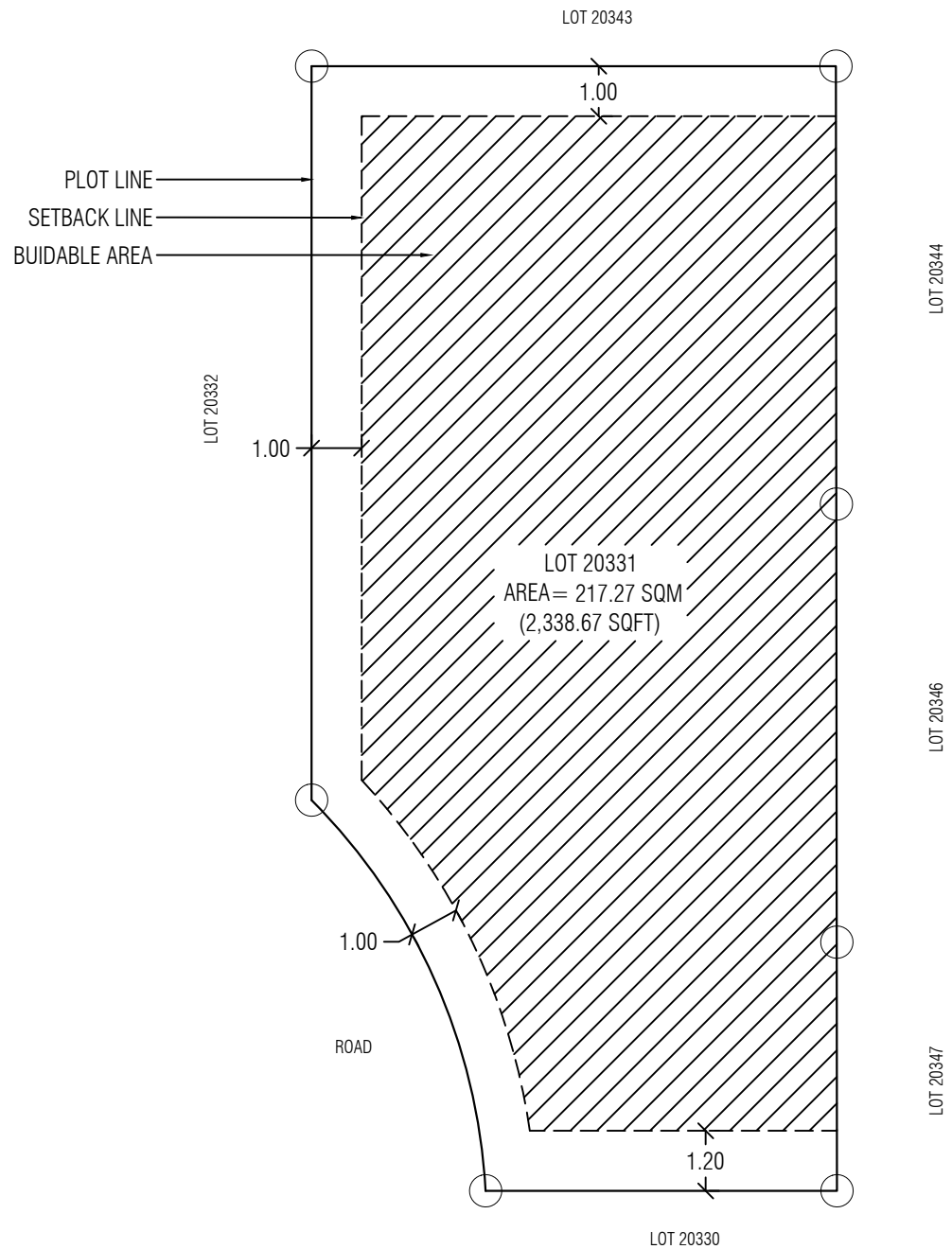

PROJECT: LOT 20331

Scale: N.T.S

Drawn by: Ziya Zaki

Checked by: Shahid Ahmed Waheed

Date: 18th October 2022

DRAWING: SETBACK PLAN

Remarks:

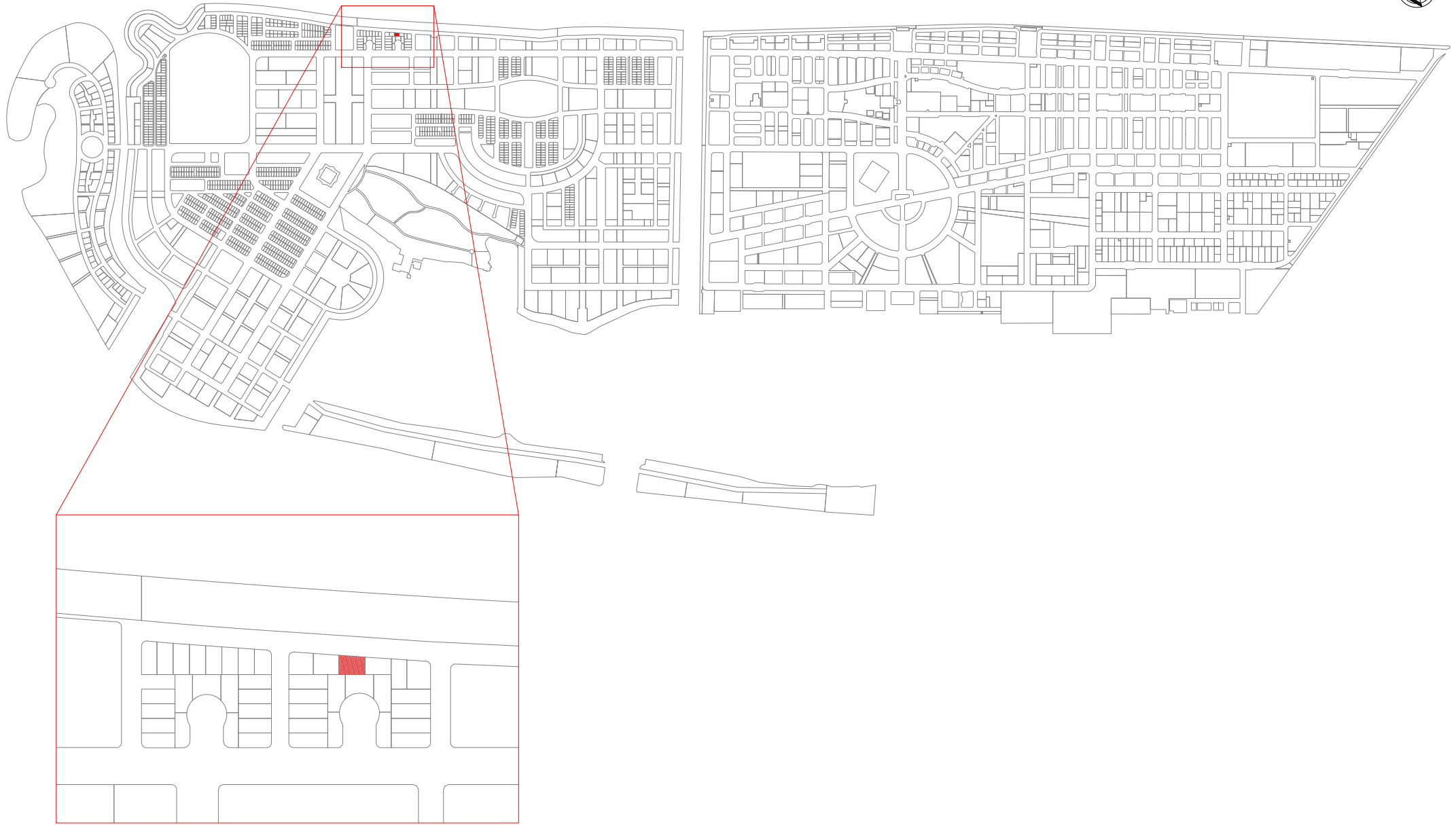

PROJECT: LOT 20342

Scale: N.T.S

Drawn by: Thorif Ibrahim

Checked by: Muhammed Ibrahim

Date: 16th October 2022

DRAWING: LOCATION MAP

Remarks:

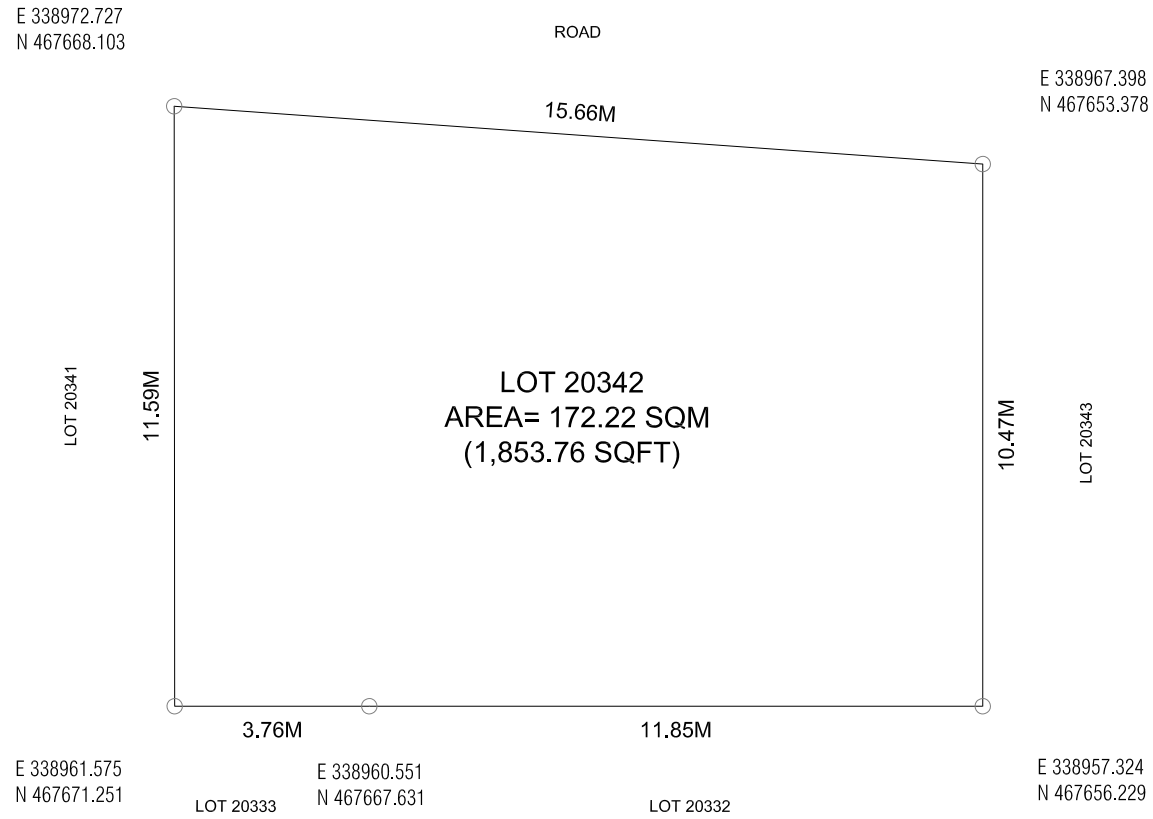

PROJECT: LOT 20342

DRAWING: PLOT MAP

Scale: N.T.S

Drawn by: Thorif Ibrahim

Checked by: Muhammed Ibrahim

Date: 16th October 2022

Remarks:

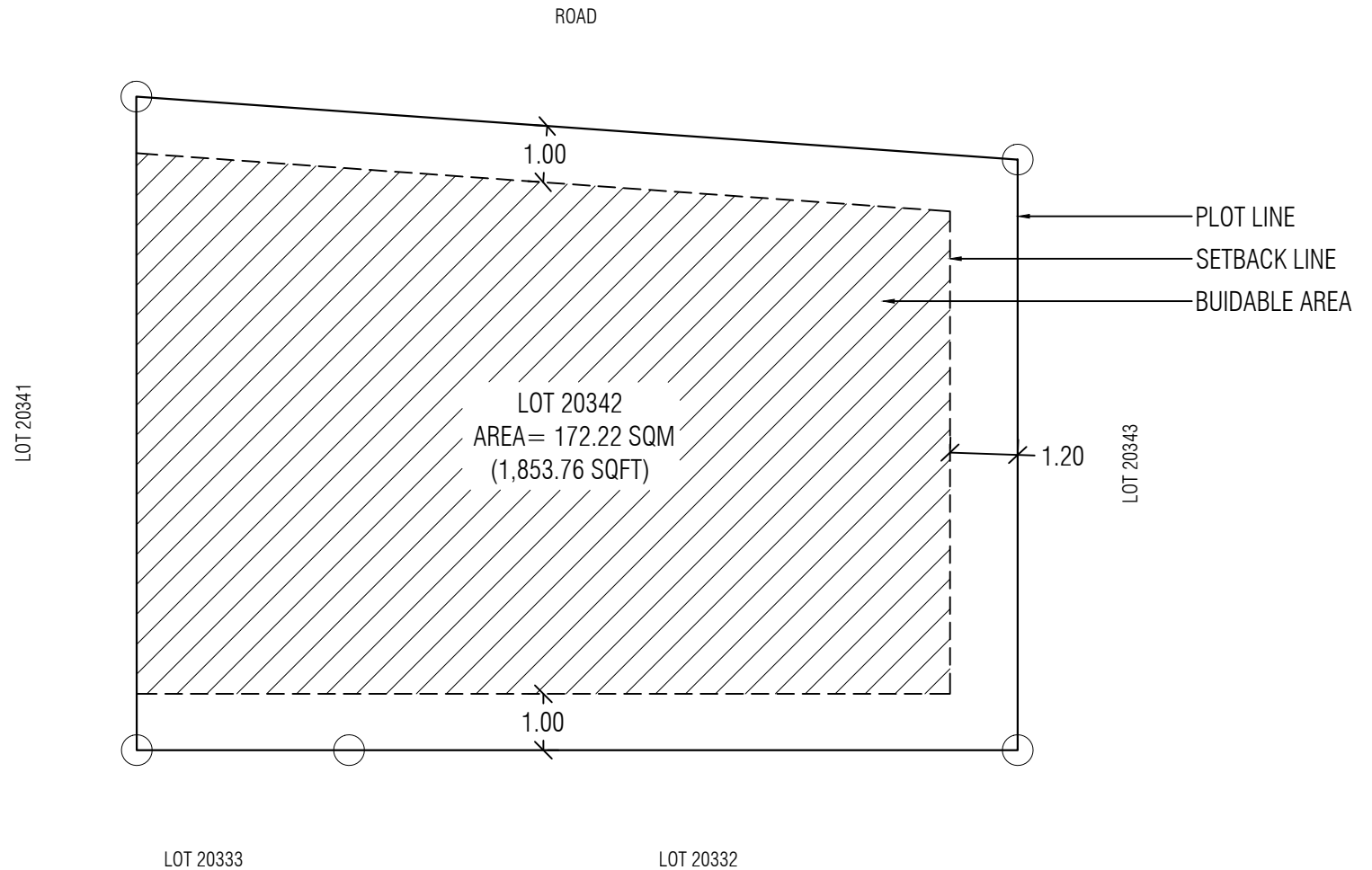

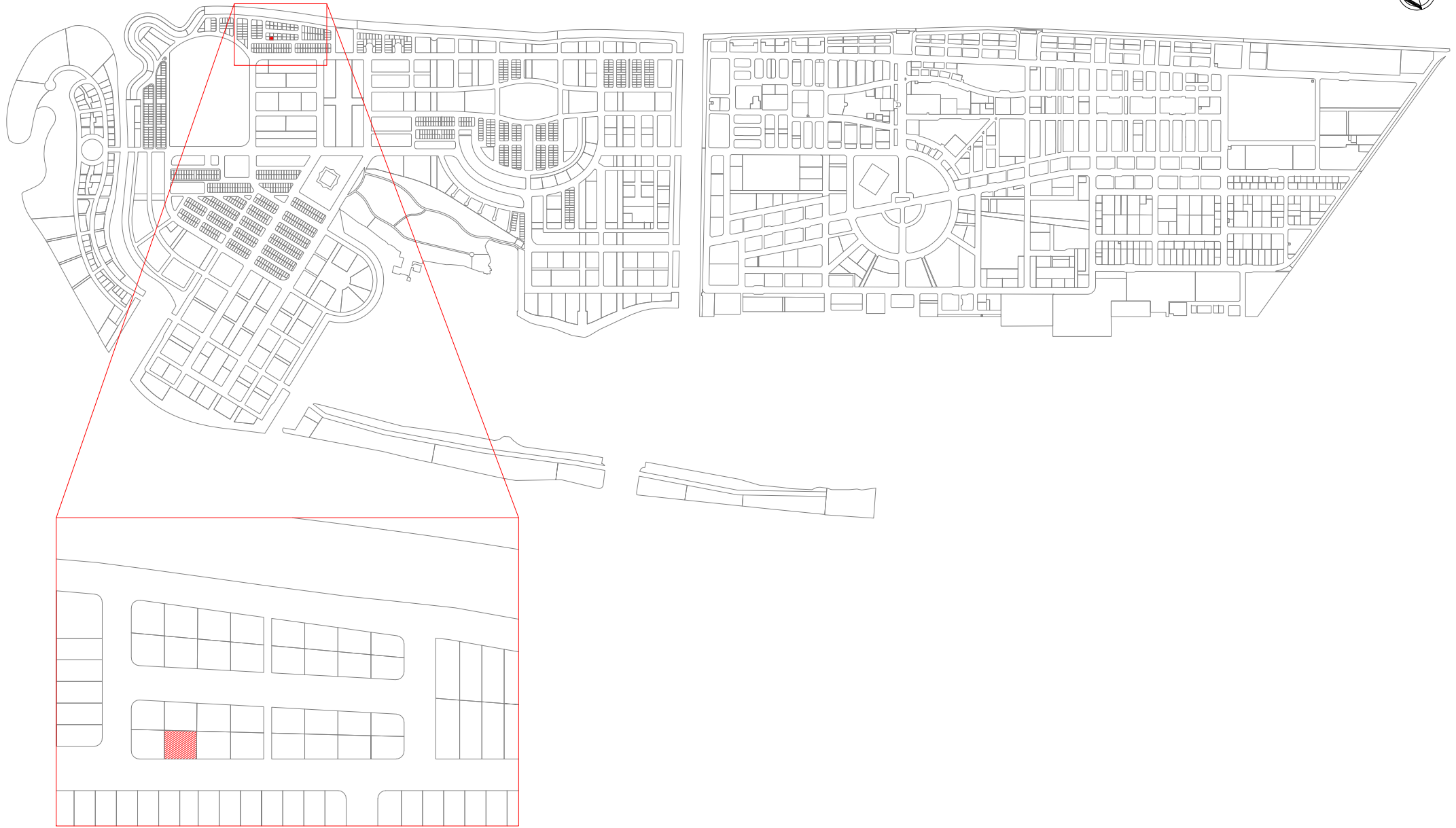

PROJECT: LOT 21719

Scale: N.T.S

Drawn by: Thorif Ibrahim

Checked by: Muhammed Ibrahim

Date: 17th October 2022

DRAWING: LOCATION MAP

Remarks:



E 339077.731
N 468050.886

LOT 21711

E 339074.092
N 468039.189

12.25M

LOT 21720

11.13M

LOT 21719
AREA= 133.86 SQM
(1,440.80 SQFT)

10.81M

LOT 21718

E 339067.022
N 468053.916

12.16M

E 339063.713
N 468042.220

ROAD



PLANNING AND DEVELOPMENT DEPARTMENT
3RD FLOOR, HDC BUILDING HULHUMALE
REPUBLIC OF MALDIVES
TEL. +(960)3353535, FAX +(960)3358892
EMAIL : planning@hdc.com.mv

PROJECT: LOT 21719

DRAWING: PLOT MAP

Scale: N.T.S

Drawn by: Thorif Ibrahim

Checked by: Muhammed Ibrahim

Date: 17th October 2022

Remarks:

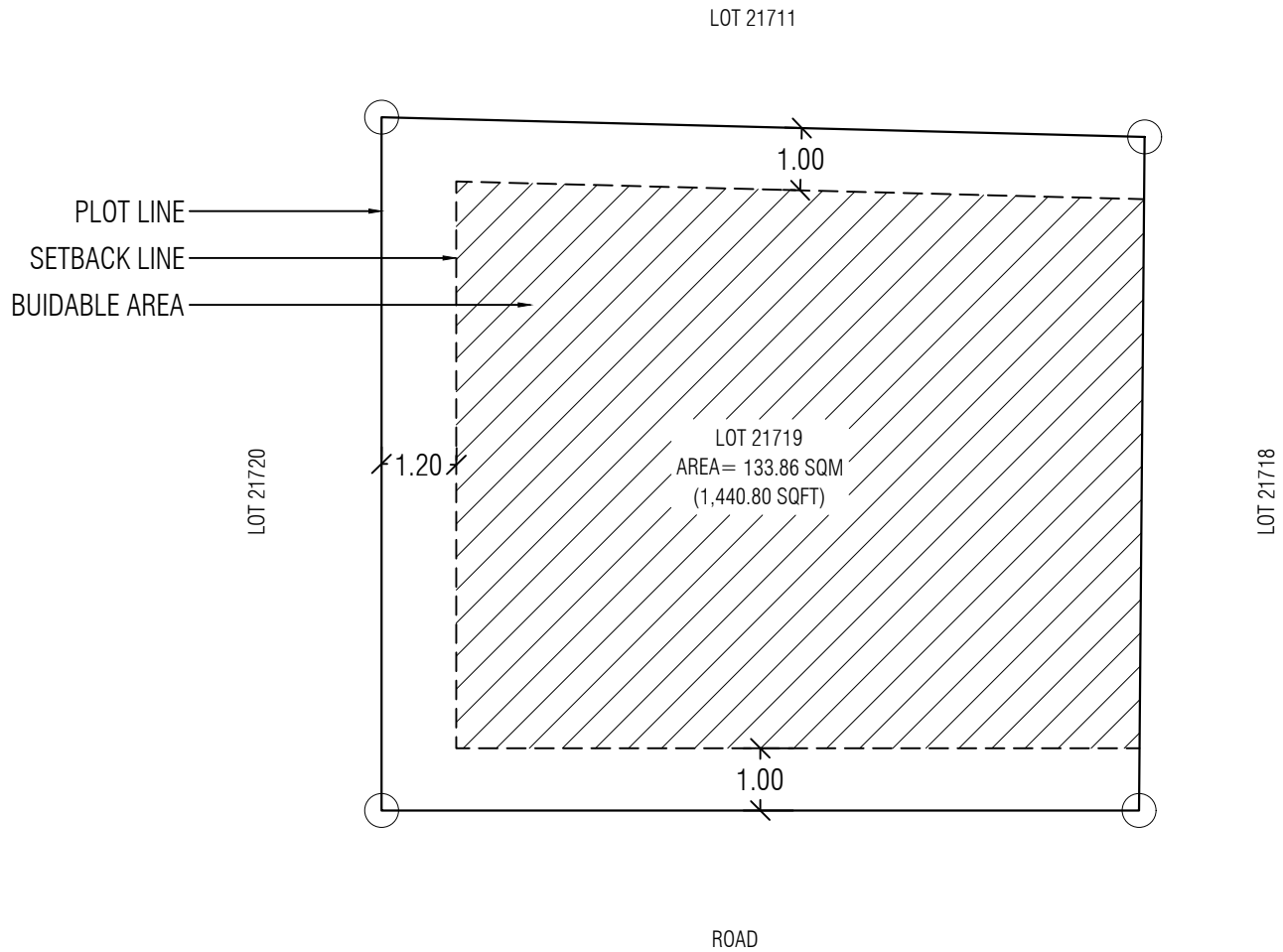

PROJECT: LOT 21719

Scale: N.T.S

Drawn by: Ziya Zaki

Checked by: Shahid Ahmed Waheed

Date: 18th October 2022

DRAWING: SETBACK PLAN

Remarks:

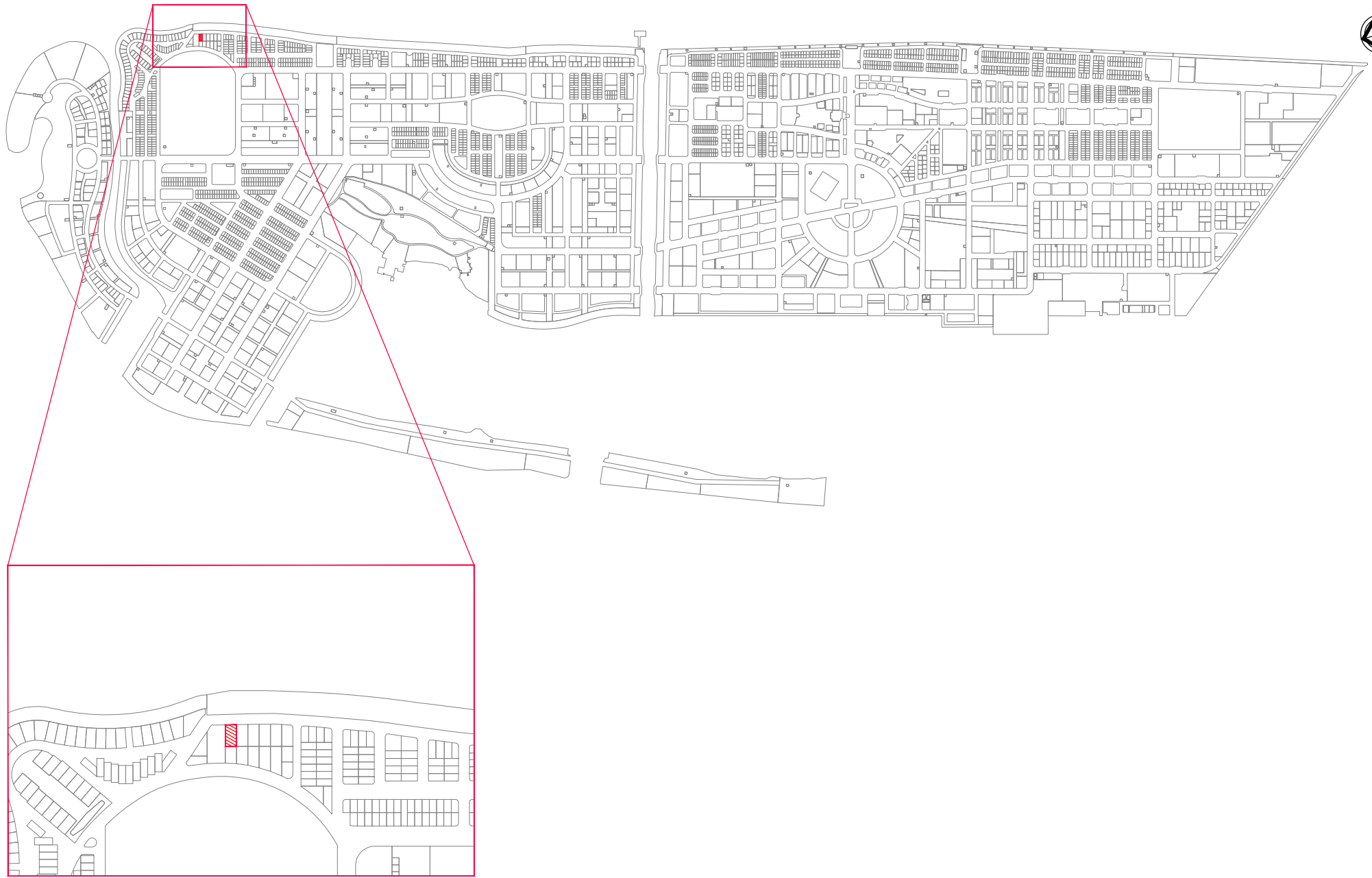

LOT 22170
(Residential Beach Plots)

Drawing Name : Location Map

Drawing Stage: Final map

Scale: N.T.S

PLANNERS

Drawn by:

Revised by:

Drawn date:
Checked by: Mohamed Razzan Abdulla

SURVEYORS

Surveyed by:

Revised by: Basith

Surveyed date:
Checked by: Ahmed Nihureer

Revised Date: 14th September 2023
Approved by: Muhammad Ibrahim



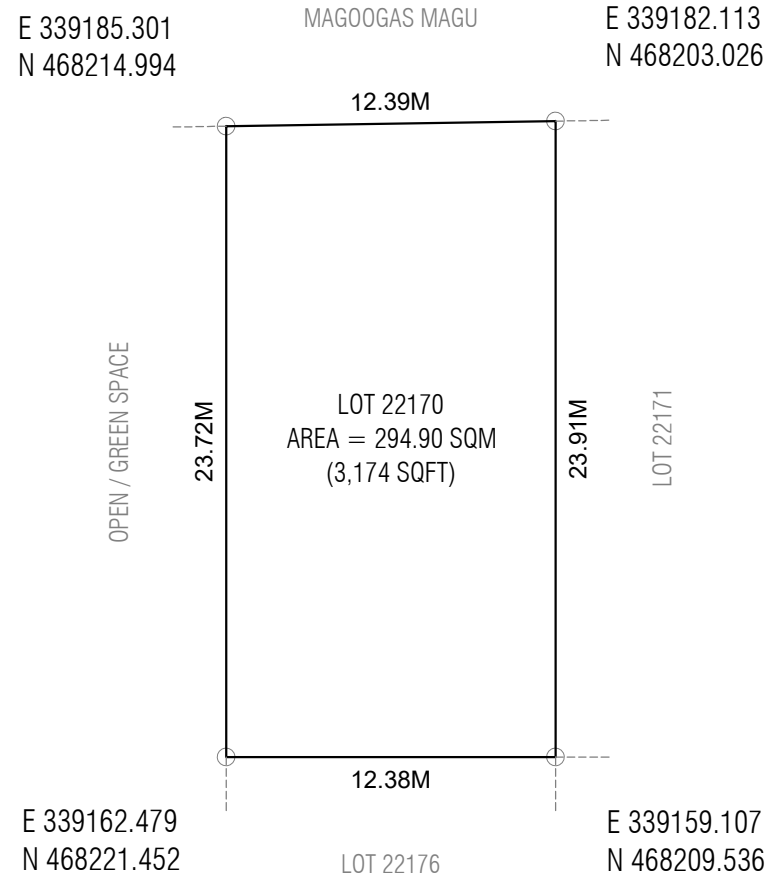

LOT 22170
(Residential Beach Plots)

Drawing Name : Plot Map

Drawing Stage: Final map

Scale: N.T.S

PLANNERS

Drawn by: _____ Revised by: _____

Drawn date: _____

Checked by: Mohamed Razzan Abdulla 

SURVEYORS

Surveyed by: _____ Revised by: Basith

Surveyed date: _____ Revised Date: 14th September 2023

Checked by: Ahmed Nihureer

Approved by: Muhammad Ibrahim 



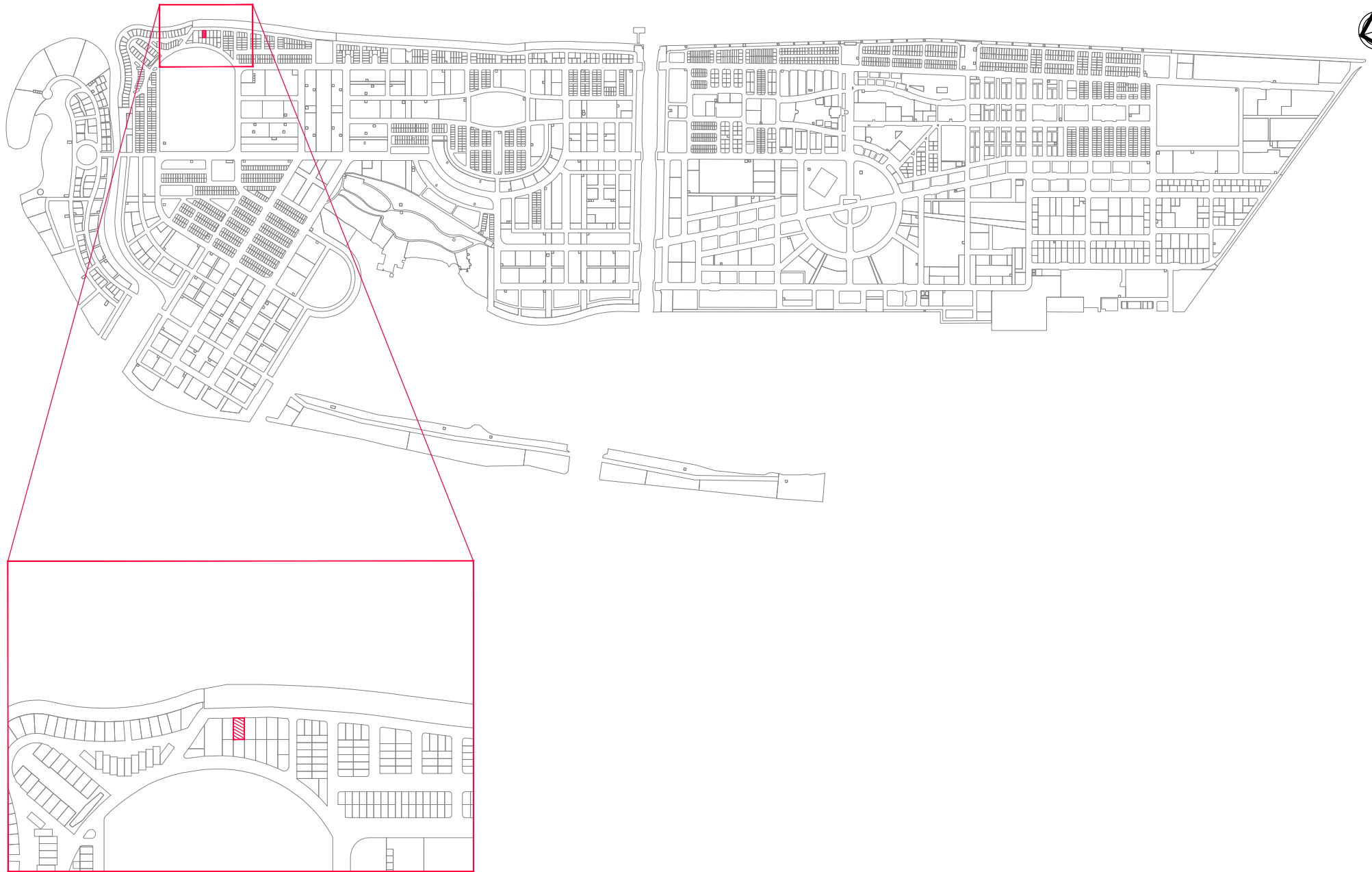

LOT 22171
(Residential Beach Plots)

Drawing Name : Location Map

Drawing Stage: Final map

Scale: N.T.S

PLANNERS

Drawn by:

Revised by:

Drawn date:

Checked by: Mohamed Razzan Abdulla

SURVEYORS

Surveyed by:

Revised by: Basith

Surveyed date:

Revised Date: 14th September 2023

Checked by: Ahmed Nihureer

Approved by: Muhammad Ibrahim



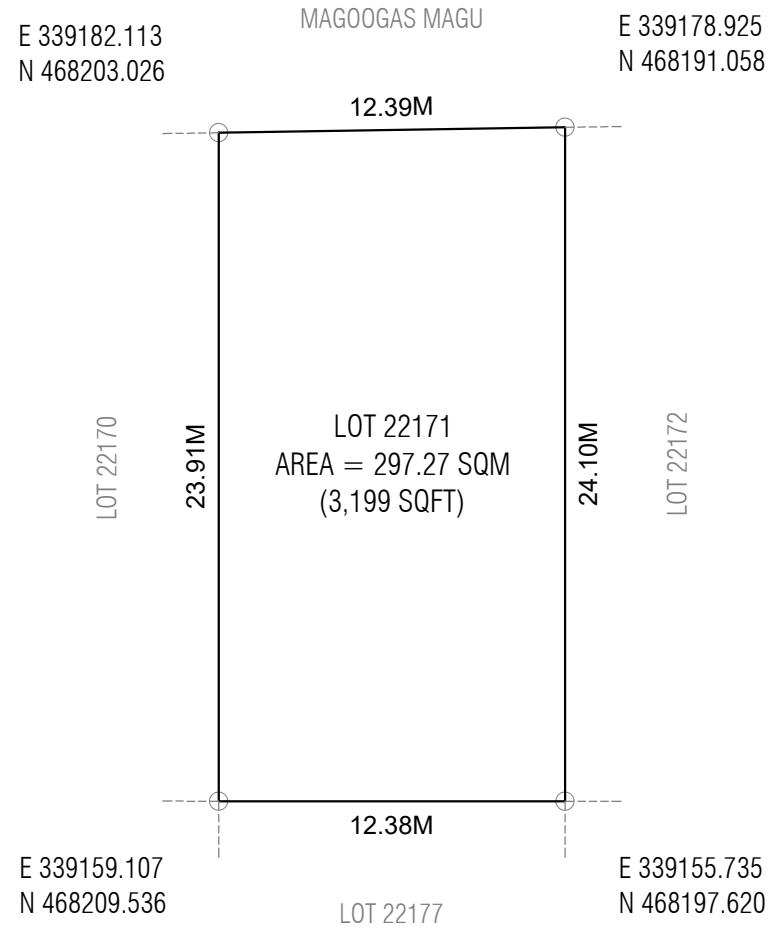

LOT 22171 (Residential Beach Plots)		
Drawing Name : Plot Map	Drawing Stage: Final map	Scale: N.T.S

PLANNERS	
Drawn by:	Revised by:
Drawn date:	
Checked by: Mohamed Razzan Abdulla	

SURVEYORS	
Surveyed by:	Revised by: Basith
Surveyed date:	
Revised Date: 14th September 2023	
Checked by: Ahmed Nihureer	
Approved by: Muhammad Ibraahim	

مؤسسة تطوير العقارات
urbanco
Housing Development Corporation Limited

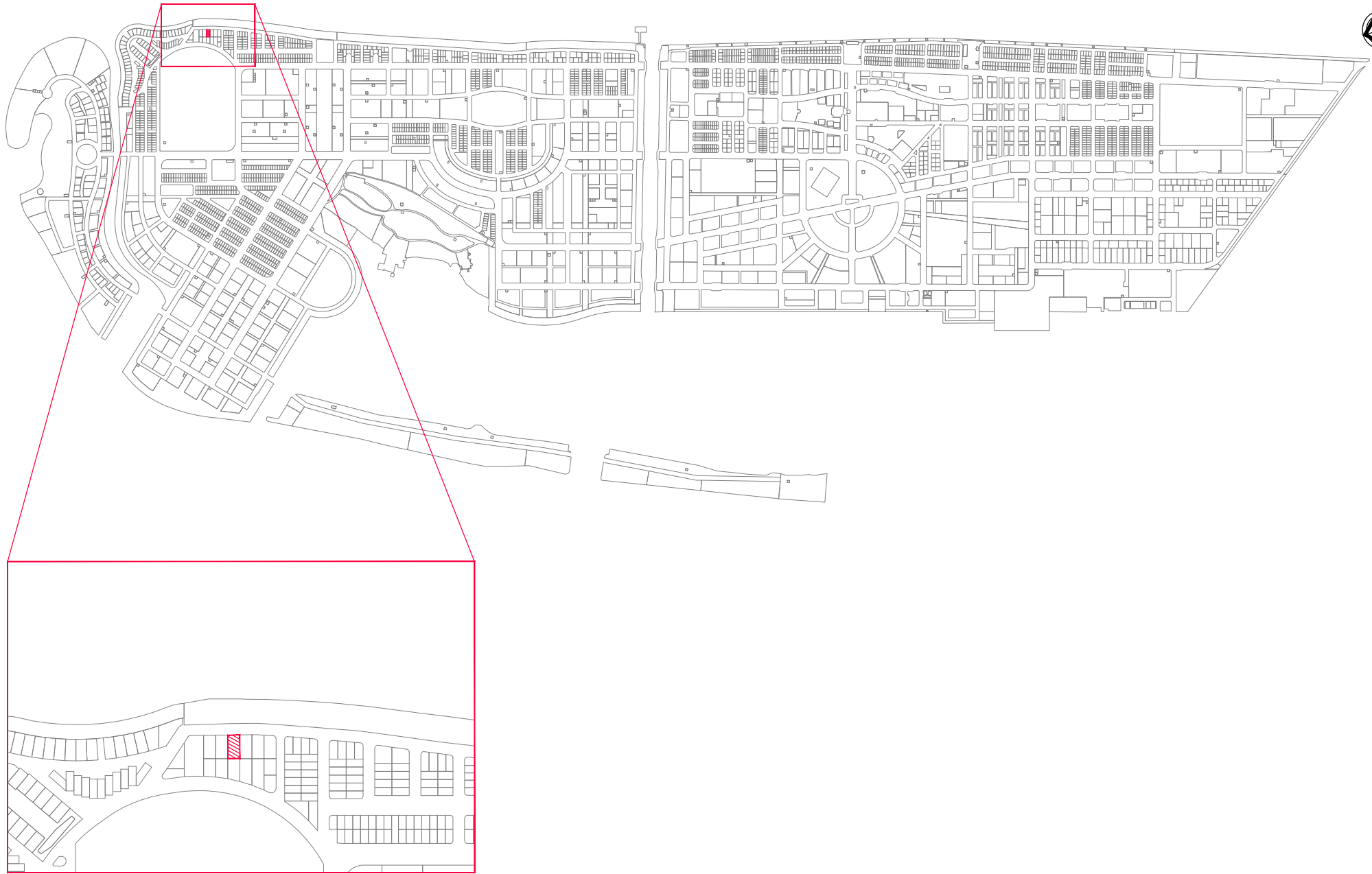

LOT 22172
(Residential Beach Plots)

Drawing Name : Location Map

Drawing Stage: Final map

Scale: N.T.S

PLANNERS

Drawn by: Revised by:

Drawn date: Checked by: Mohamed Razzan Abdulla

SURVEYORS

Surveyed by: Revised by: Basith

Surveyed date: Revised Date: 14th September 2023

Checked by: Ahmed Nihureer Approved by: Muhammad Ibraahim



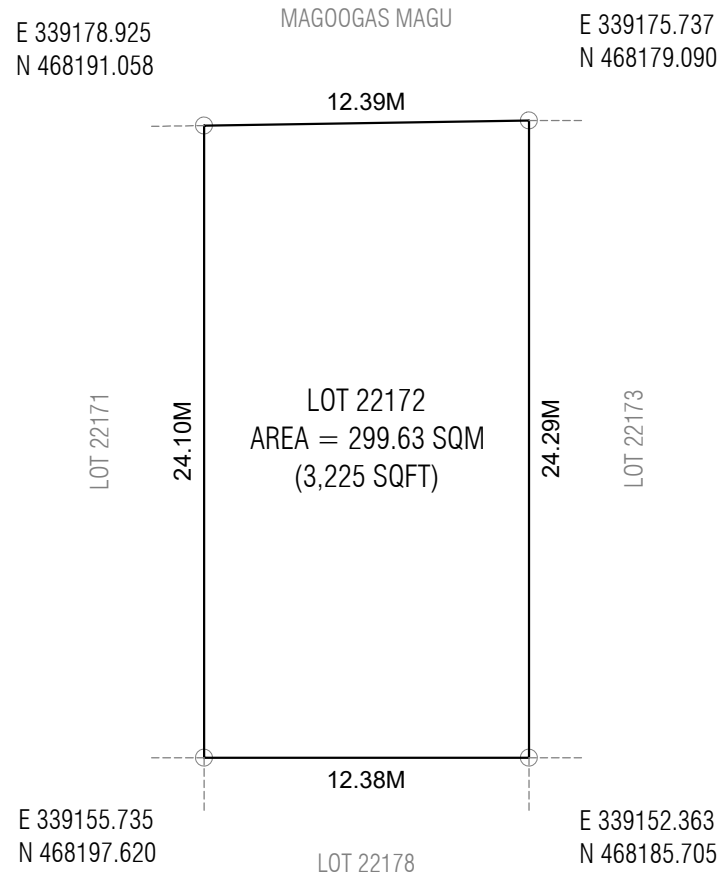

LOT 22172
(Residential Beach Plots)

Drawing Name : Plot Map

Drawing Stage: Final map

Scale: N.T.S

PLANNERS

Drawn by: _____ Revised by: _____

Drawn date: _____

Checked by: Mohamed Razzan Abdulla

SURVEYORS

Surveyed by: _____ Revised by: Basith

Surveyed date: _____ Revised Date: 14th September 2023

Checked by: Ahmed Nihureer

Approved by: Muhammad Ibraahim



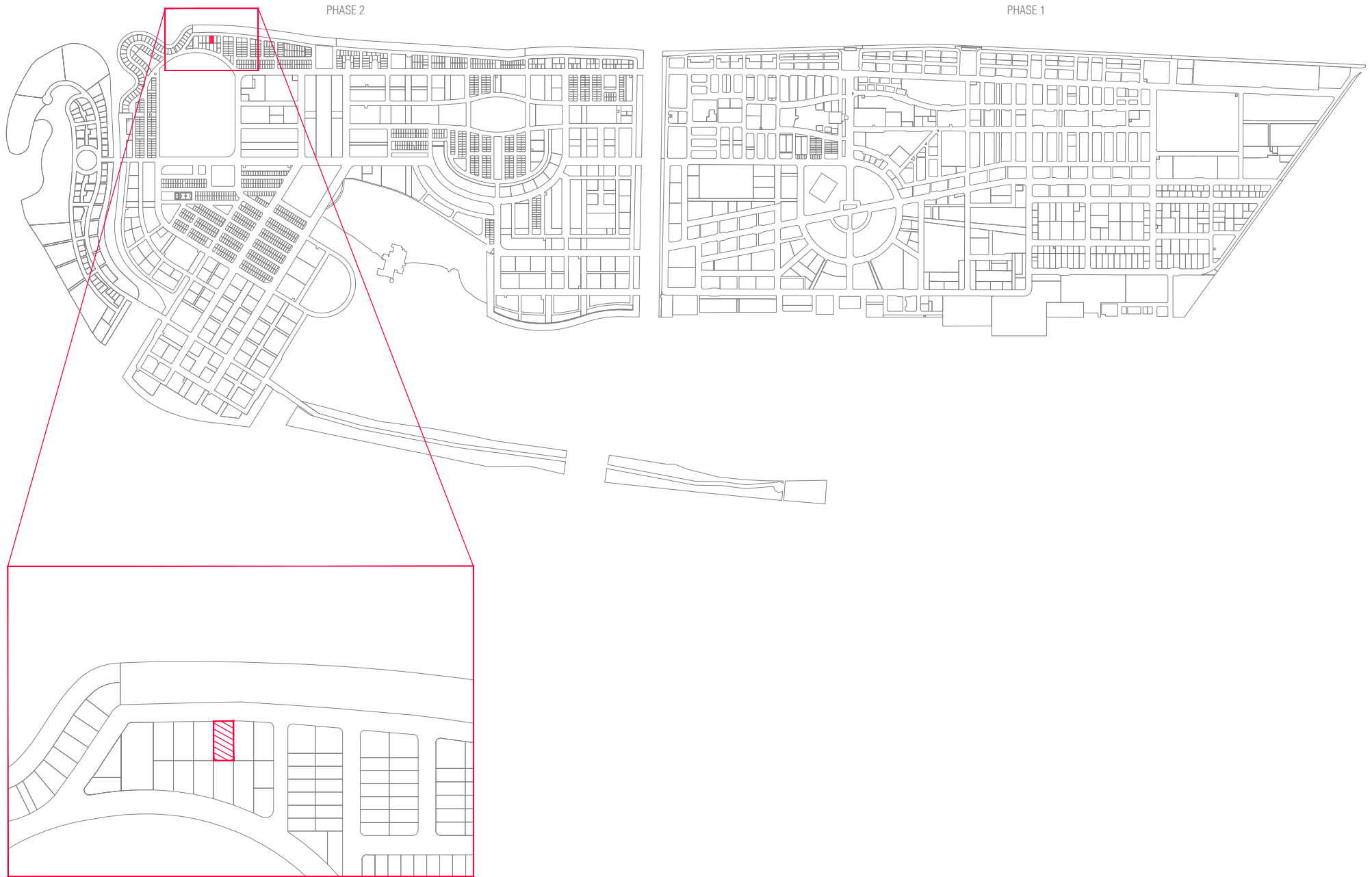

LOT 22173
(Residential Beach Plots)

Drawing Name : Location map

Drawing Stage: Final map

Scale: N.T.S

PLANNERS

Drawn by: _____ Revised by: _____
 Drawn date: _____
 Checked by: Mohamed Razzan Abdulla

SURVEYORS

Surveyed by: _____ Revised by: Basith
 Surveyed date: _____ Revised Date: 14th September 2023
 Checked by: Ahmed Nihureer Approved by: Muhammad Ibrahim



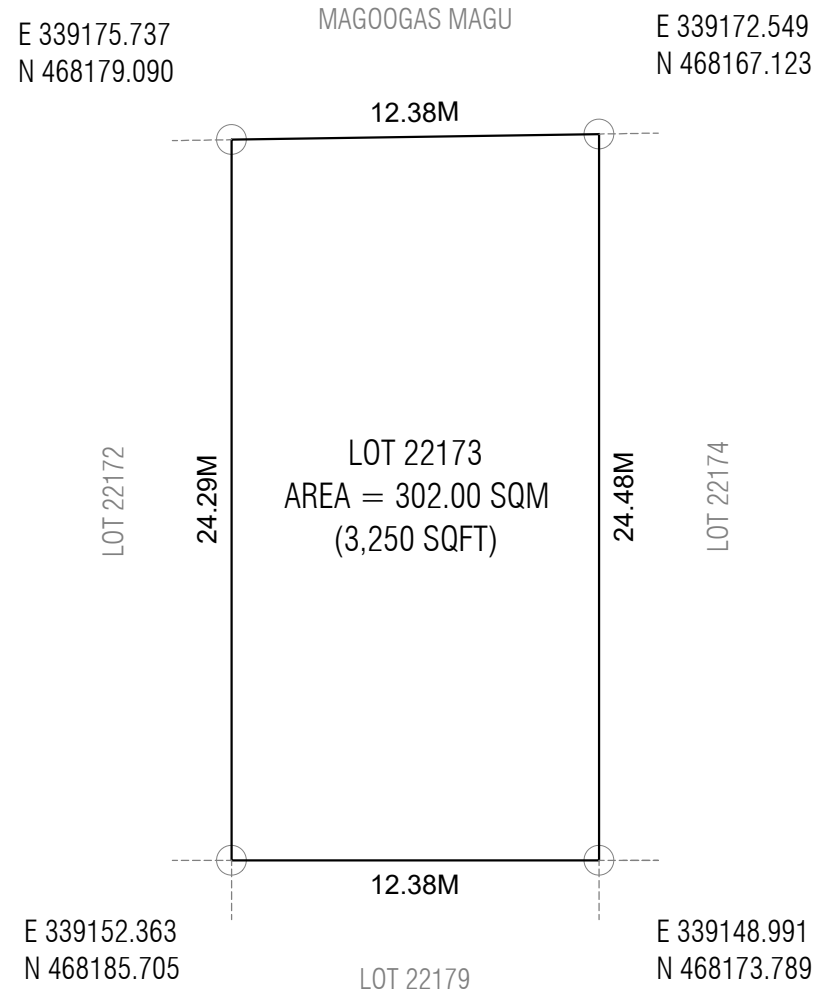

LOT 22173 (Residential Beach Plots)		
Drawing Name : Plot map	Drawing Stage: Final map	Scale: N.T.S

PLANNERS	
Drawn by:	Revised by:
Drawn date:	
Checked by: Mohamed Razzan Abdulla	

SURVEYORS	
Surveyed by:	Revised by: Basith
Surveyed date:	Revised Date: 14th September 2023
Checked by: Ahmed Nihureer	Approved by: Muhammad Ibrahim



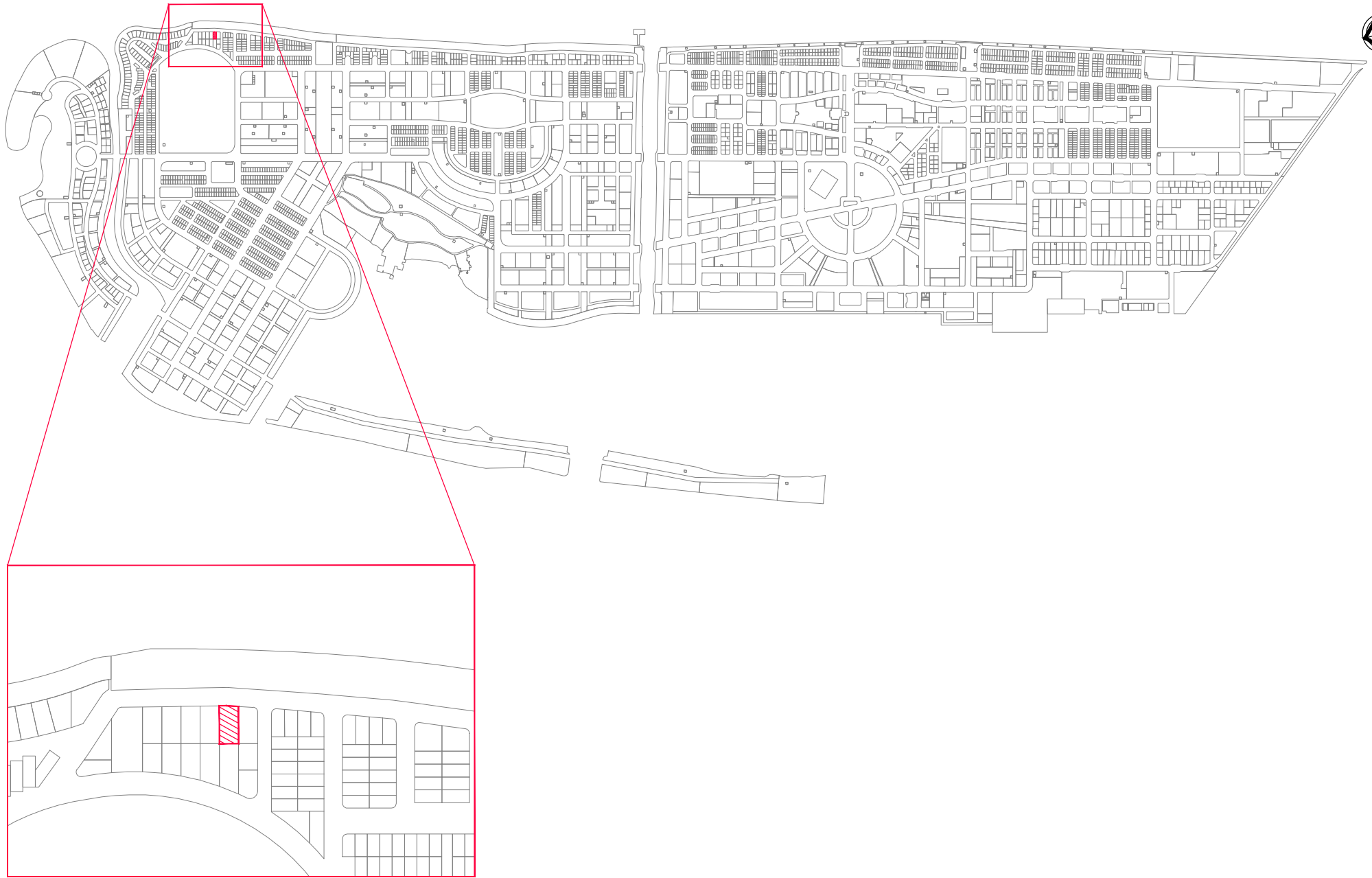

LOT 22174
(Residential Beach Plots)

Drawing Name : Location Map

Drawing Stage: Final map

Scale: N.T.S

PLANNERS

Drawn by: Revised by:

Drawn date: Checked by: Mohamed Razzan Abdulla

SURVEYORS

Surveyed by: Revised by: Basith

Surveyed date: Revised Date: 14th September 2023

Checked by: Ahmed Nihureer

Approved by: Muhammad Ibraahim





MAGOOGAS MAGU

E 339172.618 E 339171.358 E 339168.766
 N 468167.103 N 468162.652 N 468155.323

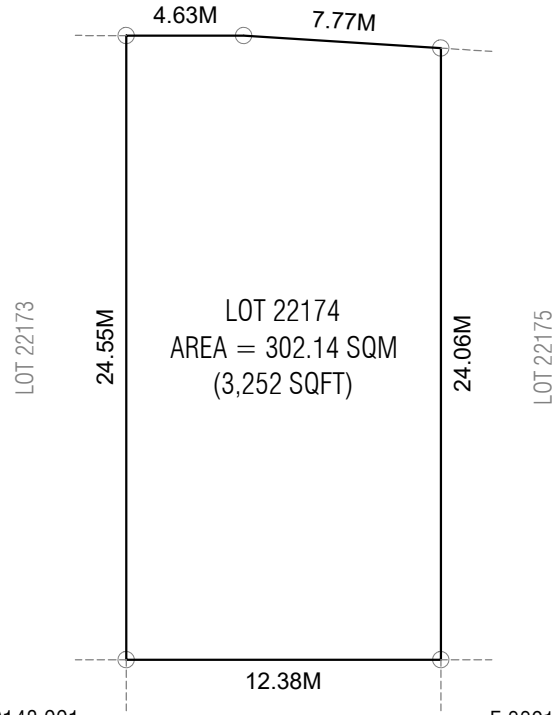

E 339148.991 E 339145.619
 N 468173.789 N 468161.873

LOT 22180

LOT 22174 (Residential Beach Plots)		
Drawing Name : Plot Map	Drawing Stage: Final map	Scale: N.T.S

PLANNERS	
Drawn by:	Revised by:
Drawn date:	
Checked by: Mohamed Razzan Abdulla	

SURVEYORS	
Surveyed by:	Revised by: Basith
Surveyed date:	Revised Date: 14th September 2023
Checked by: Ahmed Nihureer	Approved by: Muhammad Ibraahim



مؤسسة الإسكان والتنمية العمرانية
urbanco
 Housing Development Corporation Limited

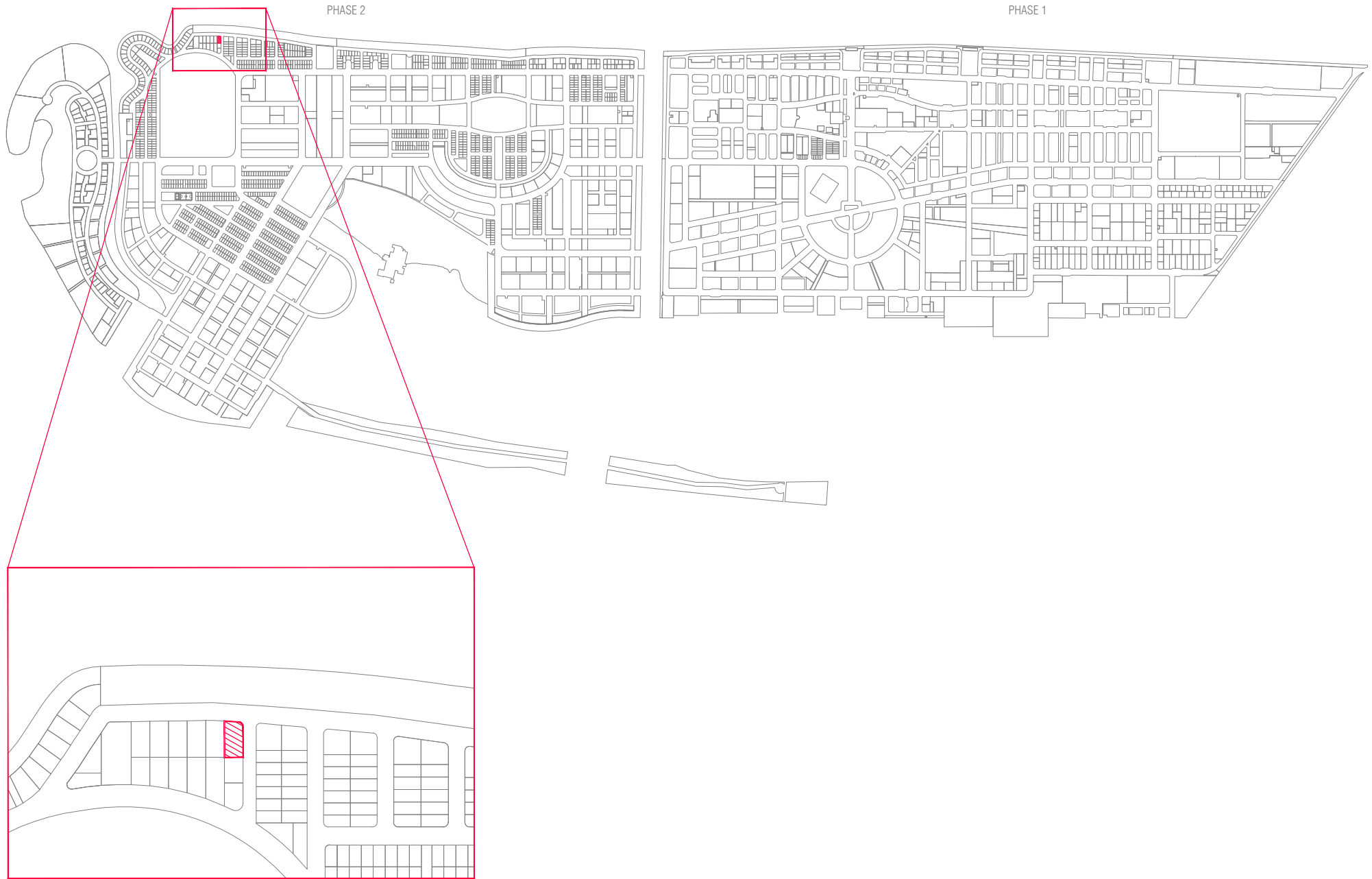

LOT 22175
(Residential Beach Plots)

Drawing Name : Location map

Drawing Stage: Final map

Scale: N.T.S

PLANNERS

Drawn by:

Revised by:

Drawn date:

Checked by: Mohamed Razzan Abdulla

SURVEYORS

Surveyed by:

Revised by: Basith

Surveyed date:

Revised Date: 14th September 2023

Checked by: Ahmed Nihureer

Approved by: Muhammad Ibrahim





MAGOOGAS MAGU

E 339168.766
N 468155.323

E 339165.566
N 468146.277

E 339164.116
N 468144.613

E 339161.921
N 468144.390

E 339145.619
N 468161.873

E 339142.248
N 468149.958

LOT 22174

LOT 22175
AREA = 290.67 SQM
(3,128 SQFT)

LOT 22182

24.06M

9.60M

2.21M

2.21M

20.45M

12.38M

ROAD

LOT 22175
(Residential Beach Plots)

Drawing Name : Plot map

Drawing Stage: Final map

Scale: N.T.S

PLANNERS

Drawn by: Revised by:

Drawn date:
Checked by: Mohamed Razzan Abdulla

SURVEYORS

Surveyed by: Revised by: Basith

Surveyed date: Revised Date: 14th September 2023

Checked by: Ahmed Nihureer

Approved by: Muhammad Ibraahim



PHASE 2

PHASE 1



LOT 22176
(Residential Beach Plots)

Drawing Name : Location map

Drawing Stage: Final map

Scale: N.T.S

PLANNERS

Drawn by:

Revised by:

Drawn date:
Checked by: Mohamed Razzan Abdulla

SURVEYORS

Surveyed by:

Revised by: Basith

Surveyed date:
Checked by: Ahmed Nihureer

Revised Date: 24th September 2023
Approved by: Muhammad Ibrahim



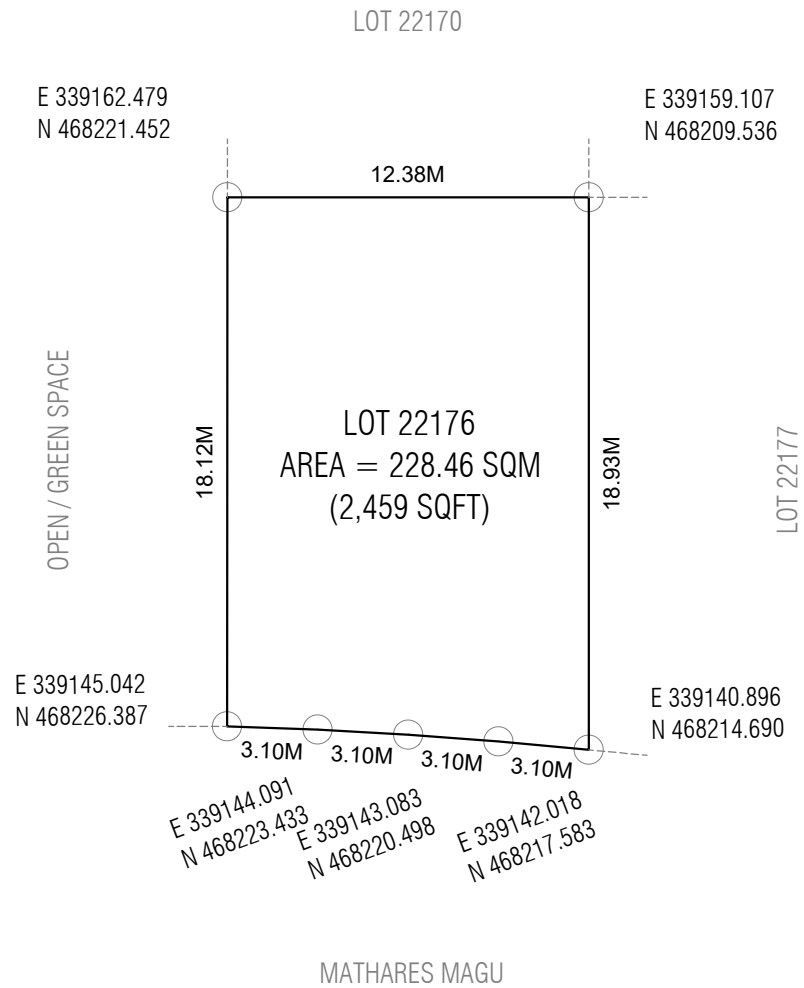

LOT 22176 (Residential Beach Plots)		
Drawing Name : Plot map	Drawing Stage: Final map	Scale: N.T.S

PLANNERS	
Drawn by:	Revised by:
Drawn date:	
Checked by: Mohamed Razzan Abdulla	

SURVEYORS	
Surveyed by:	Revised by: Basith
Surveyed date:	
Revised Date: 24th September 2023	
Checked by: Ahmed Nihureer	
Approved by: Muhammad Ibrahim	

مؤسسة تطوير العقارات
Urbanco
Housing Development Corporation Limited

PHASE 2

PHASE 1



LOT 22177
(Residential Beach Plots)

Drawing Name : Location map

Drawing Stage: Final map

Scale: N.T.S

PLANNERS

Drawn by:

Revised by:

Drawn date:
Checked by: Mohamed Razzan Abdulla

SURVEYORS

Surveyed by:

Revised by: Basith

Surveyed date:
Checked by: Ahmed Nihureer

Revised Date: 24th September 2023
Approved by: Muhammad Ibrahim





LOT 22171

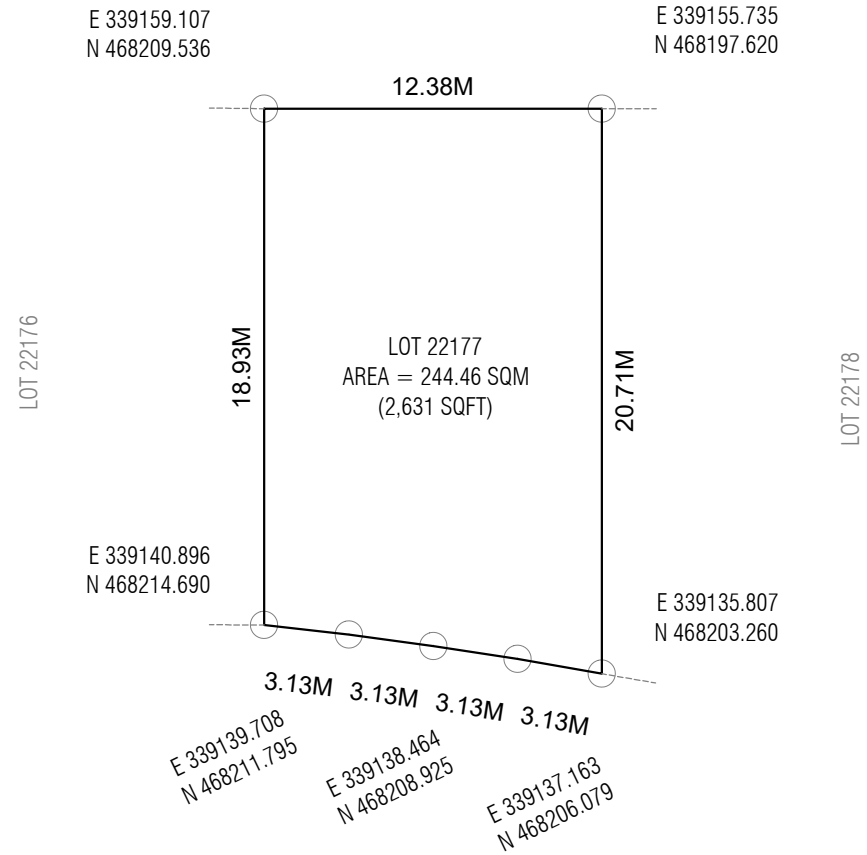

MATHARES MAGU

LOT 22177
(Residential Beach Plots)

Drawing Name : Plot map

Drawing Stage: Final map

Scale: N.T.S

PLANNERS

Drawn by: Revised by:

Drawn date:
Checked by: Mohamed Razzan Abdulla

SURVEYORS

Surveyed by: Revised by: Basith

Surveyed date: Revised Date: 24th September 2023

Checked by: Ahmed Nihureer

Approved by: Muhammad Ibrahim



PHASE 2

PHASE 1

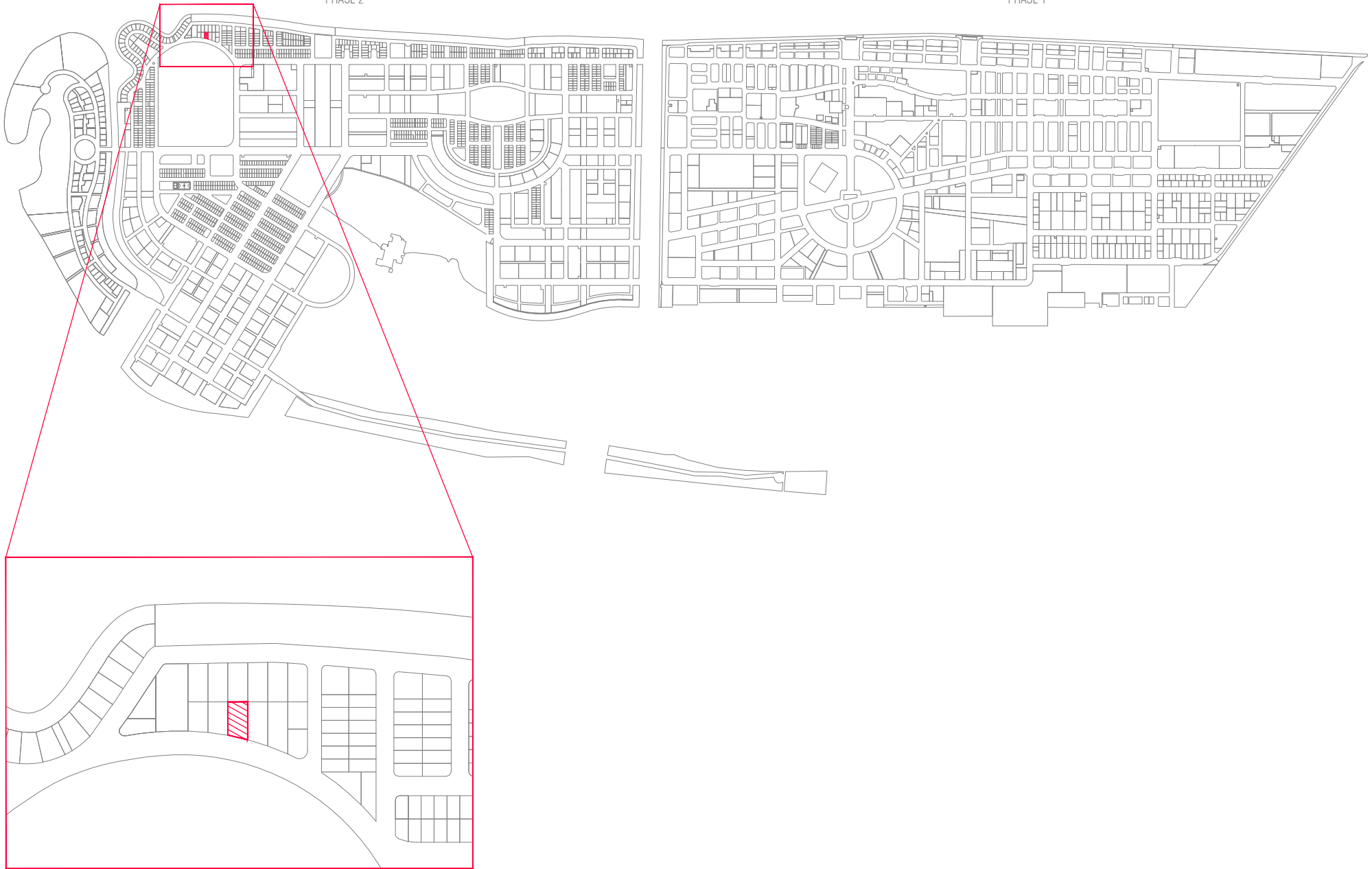

LOT 22178
(Residential Beach Plots)

Drawing Name : Location map

Drawing Stage: Final map

Scale: N.T.S

PLANNERS

Drawn by:

Revised by:

Drawn date:
Checked by: Mohamed Razzan Abdulla

SURVEYORS

Surveyed by:

Revised by: Basith

Surveyed date:
Checked by: Ahmed Nihureer

Revised Date: 25th September 2023
Approved by: Muhammad Ibrahim





LOT 22173

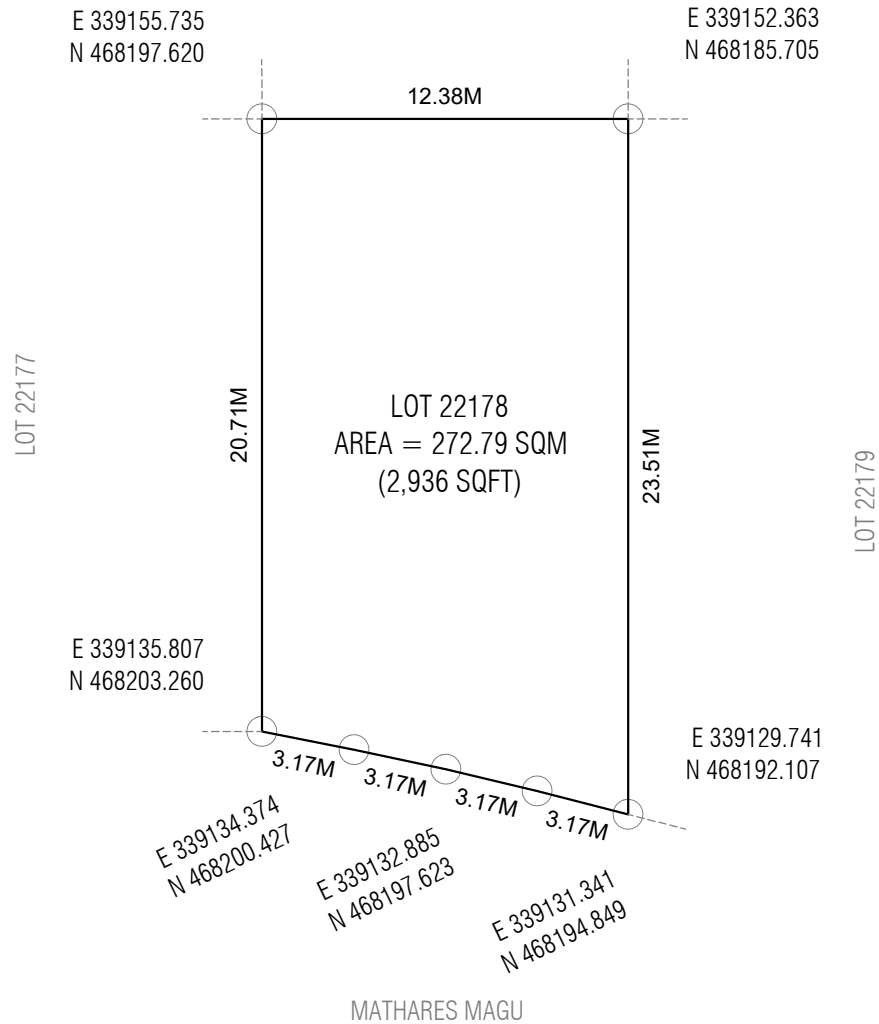

LOT 22178
(Residential Beach Plots)

Drawing Name : Plot map

Drawing Stage: Final map

Scale: N.T.S

PLANNERS

Drawn by: Revised by:

Drawn date:

Checked by: Mohamed Razzan Abdulla

SURVEYORS

Surveyed by: Revised by: Basith

Surveyed date: Revised Date: 25th September 2023

Checked by: Ahmed Nihureer

Approved by: Muhammad Ibrahim



PHASE 2

PHASE 1



LOT 22179
(Residential Beach Plots)

Drawing Name : Location map

Drawing Stage: Final map

Scale: N.T.S

PLANNERS

Drawn by: Revised by:

Drawn date: Checked by: Mohamed Razzan Abdulla

SURVEYORS

Surveyed by: Revised by: Basith

Surveyed date: Revised Date: 25th September 2023

Checked by: Ahmed Nihureer

Approved by: Muhammad Ibrahim



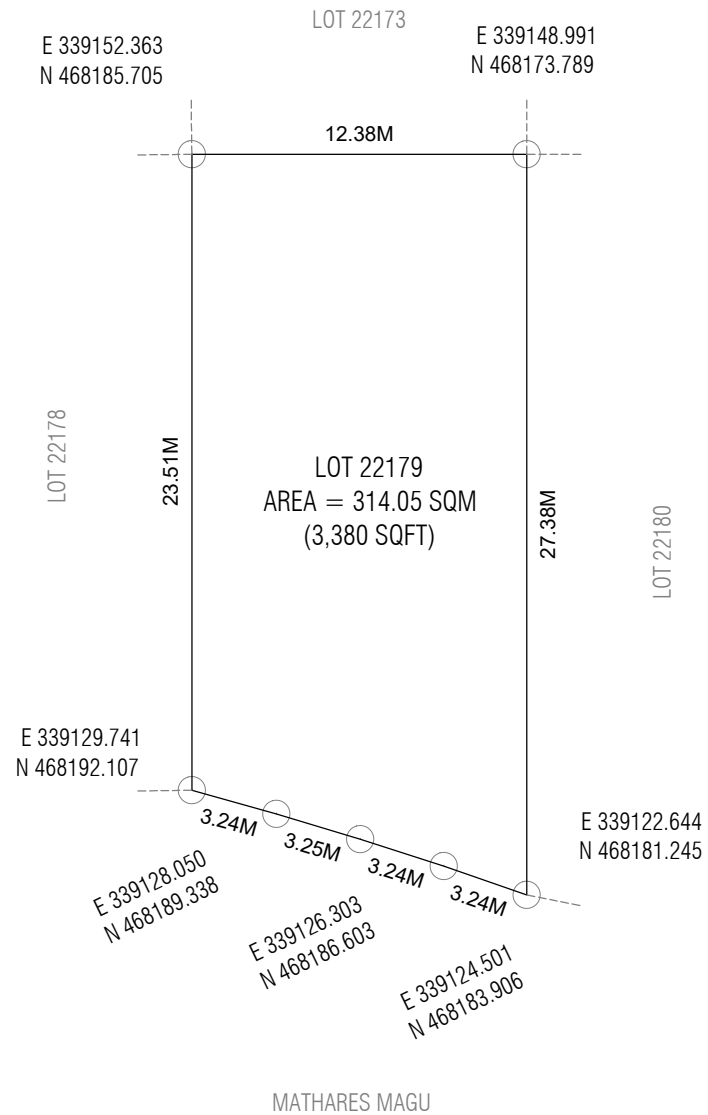

LOT 22179
(Residential Beach Plots)

Drawing Name : Plot map

Drawing Stage: Final map

Scale: N.T.S

PLANNERS

Drawn by: _____ Revised by: _____

Drawn date: _____

Checked by: Mohamed Razzan Abdulla

SURVEYORS

Surveyed by: _____ Revised by: Basith

Surveyed date: _____ Revised Date: 25th September 2023

Checked by: Ahmed Nihureer

Approved by: Muhammad Ibrahim



PHASE 2

PHASE 1

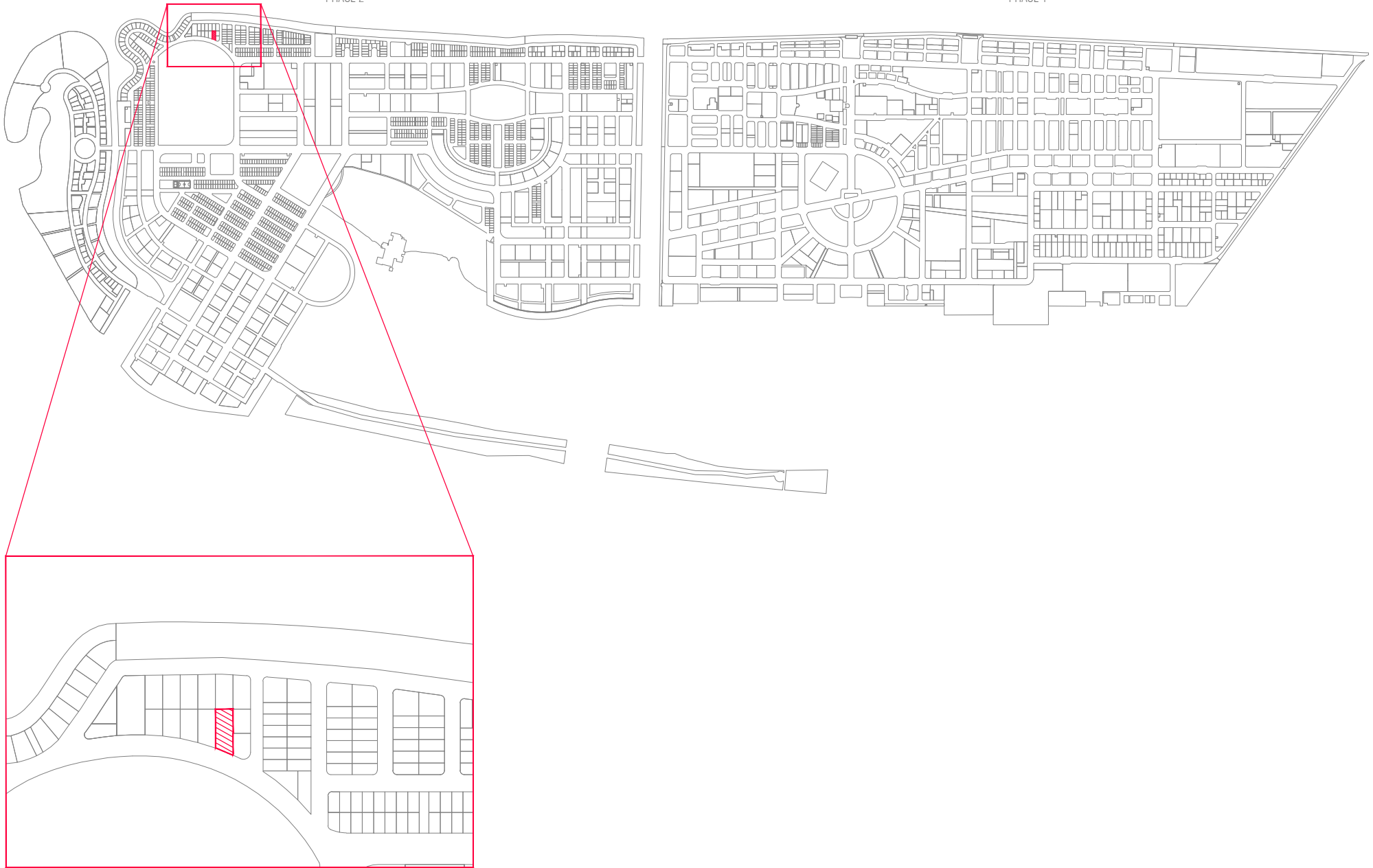

LOT 22180
(Residential Beach Plots)

Drawing Name : Location map

Drawing Stage: Final map

Scale: N.T.S

PLANNERS

Drawn by:

Revised by:

Drawn date:
Checked by: Mohamed Razzan Abdulla

SURVEYORS

Surveyed by:

Revised by: Basith

Surveyed date:
Checked by: Ahmed Nihureer

Revised Date: 25th September 2023
Approved by: Muhammad Ibrahim



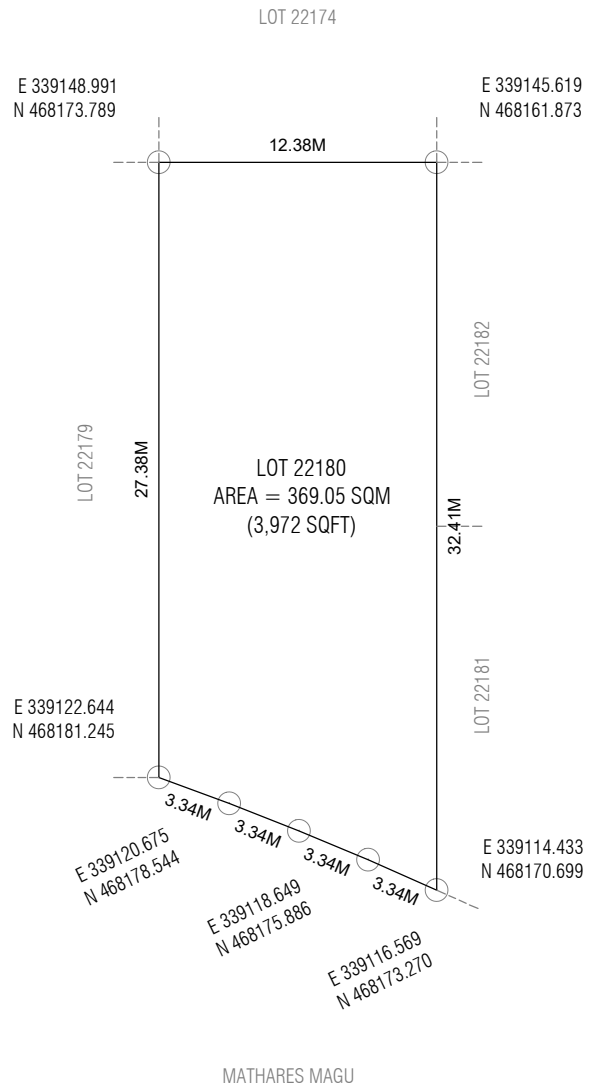

LOT 22180 (Residential Beach Plots)		
Drawing Name : Plot map	Drawing Stage: Final map	Scale: N.T.S

PLANNERS	
Drawn by:	Revised by:
Drawn date:	
Checked by: Mohamed Razzan Abdulla	

SURVEYORS	
Surveyed by:	Revised by: Basith
Surveyed date:	
Revised Date: 25th September 2023	
Checked by: Ahmed Nihureer	
Approved by: Muhammad Ibraahim	



PHASE 2

PHASE 1

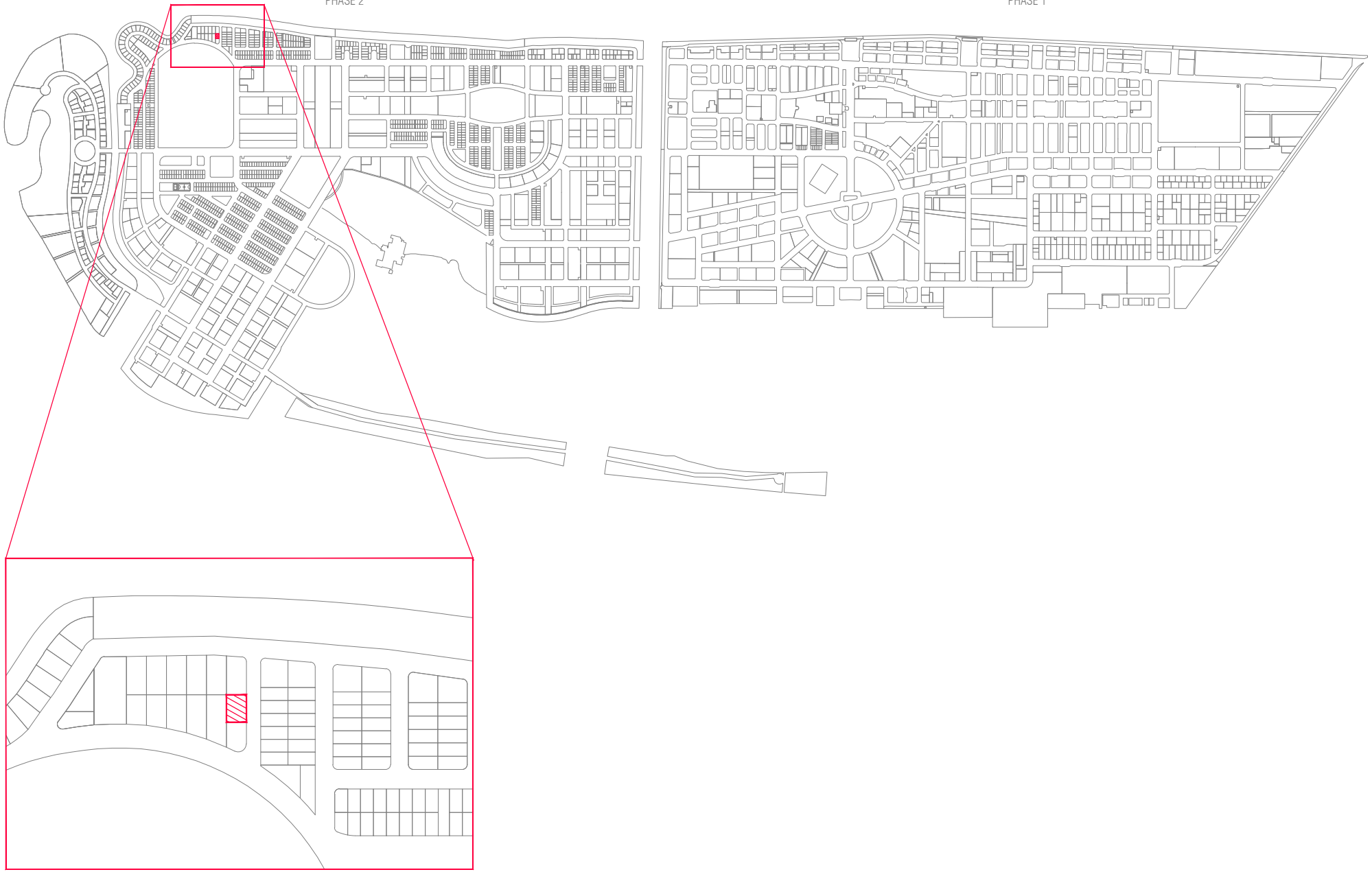

LOT 22182
(Residential Beach Plots)

Drawing Name : Location map

Drawing Stage: Final map

Scale: N.T.S

PLANNERS

Drawn by:

Revised by:

Drawn date:
Checked by: Mohamed Razzan Abdulla

SURVEYORS

Surveyed by:

Revised by: Basith

Surveyed date:
Checked by: Ahmed Nihureer

Revised Date: 25th September 2023
Approved by: Muhammad Ibrahim



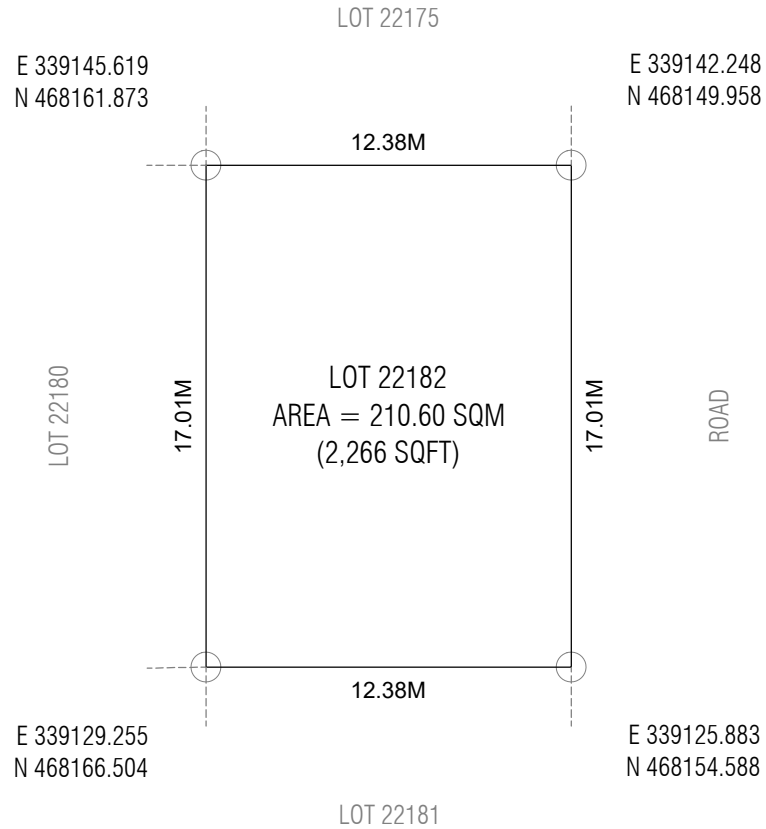

LOT 22182 (Residential Beach Plots)		
Drawing Name : Plot map	Drawing Stage: Final map	Scale: N.T.S

PLANNERS	
Drawn by:	Revised by:
Drawn date:	
Checked by: Mohamed Razzan Abdulla	

SURVEYORS	
Surveyed by:	Revised by: Basith
Surveyed date:	Revised Date: 25th September 2023
Checked by: Ahmed Nihureer	Approved by: Muhammad Ibrahim



مؤسسة تطوير العقارات
urbanco
 Housing Development Corporation Limited